

TECHNICAL DATA SHEET

DPA 250 S4 UPS

50-250 kW 380/400/415 V IEC

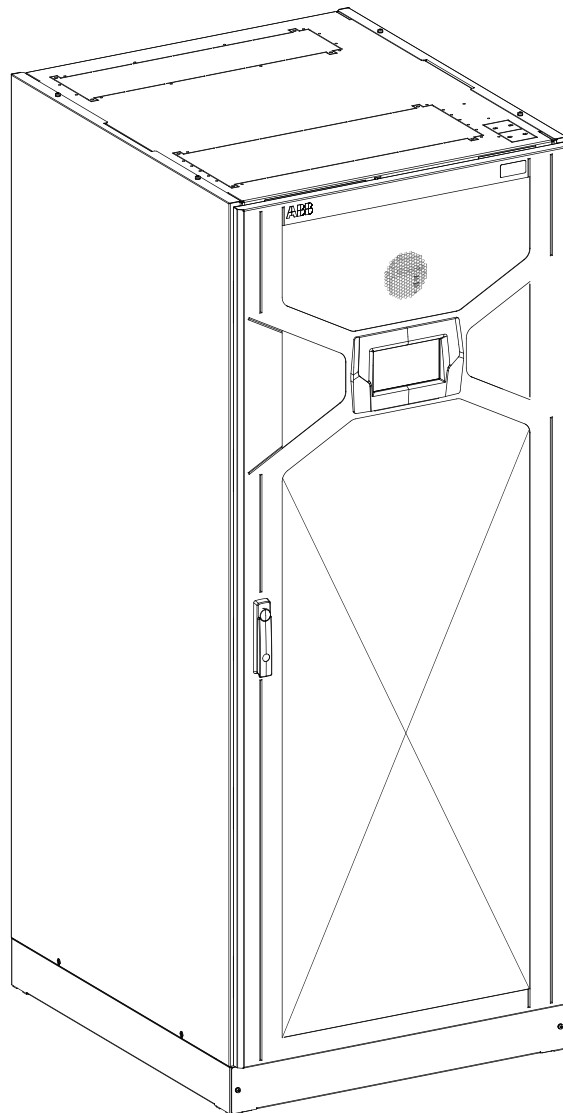

About this document

Document information

File name	:	4NWD004067_TDS_ABB_DPA-S4_250_EN_REV-C
UPS model	:	DPA 250 S4 50-250kW
Date of issue	:	21.01.2019
Issued by	:	Product Marketing
Checked by	:	R&D After Sales
Article number	:	N/A
Document number	:	4NWD004067
Revision	:	C

Contents

1	Introduction	4
1.1	Key features and benefits	4
1.2	System identification	6
1.2.1	DPA 250 S4 250 kW (N+1) UPS frame types - Bottom cable entry	6
1.2.2	DPA 250 S4 250 kW (N+1) UPS frame types - Top cable entry	7
1.2.3	DPA 250 S4 50 kW UPS module	7
1.2.4	UPS Standalone configuration	8
1.2.5	Parallel system configuration	9
1.3	Mechanical and safety characteristics	10
1.4	Electromagnetic compatibility	10
1.5	Environmental characteristics	10
2	Input electrical characteristics	11
2.1	Input AC power distribution system	11
2.2	Input voltage and frequency	11
2.3	Input current and overload characteristics	12
3	Output electrical characteristics	13
4	Battery and energy storage	15
5	Control & Monitoring	16
5.1	System display	16
5.2	Control panel UPS Module	16
5.3	Communication interfaces	17
5.3.1	Input dry ports (X3)	17
5.3.2	Output dry port (X2 and X1)	18
5.3.3	Network Management cards (option)	18
6	Options and accessories	19
7	Site planning information	20
7.1	Installation footprint and clearances	20
7.2	Single line diagrams for common configurations	21
7.2.1	Single input feed and common battery (default)	21
7.2.2	Single input feed and separate battery	22
7.2.3	Dual input feed and common battery	23
7.2.4	Dual input feed and separate battery	24
7.3	UPS terminal sizes	25
7.4	Heat dissipation	25

1 Introduction

ABB's DPA 250 S4 is a high-efficiency, modular UPS system for organizations that need zero downtime and low cost of ownership. The DPA 250 S4 is specially designed for critical, high-density

computing environments such as small-to-medium data centers, commercial and financial buildings, health care facilities and transportation infrastructures.

1.1 Key features and benefits

Uninterruptible power – scalable from 50 kW up to 1.5 MW.



250 kW N+1 redundant power in one UPS cabinet

The DPA 250 S4 250 kW cabinet can host up to six 50 kW modules for 250 kW N+1 redundant power. Modules are easy to slide in and slide out. Featuring smart and secure power connectors, the DPA 250 module can be removed, or added, while other UPS modules in the system support the load in double conversion mode



1,500 kW power in one UPS system

Up to six 250 kW frames - ie, up to 30 modules - can be paralleled for amazing 1,500 kW of uninterrupted power. The secure ring communication ensures there is no single point of failure in the system.

Maximized availability with decentralized parallel architecture, DPA.



Secured uptime and reliable performance

With decentralized paralleling architecture (DPA) all UPS modules include all necessary functional parts, such as rectifier, inverter, battery converter, static bypass and back-feed protection. This allows the modules to be fully redundant with each other for maximum reliability.



Online swappable module for continuous uptime

DPA architecture enables UPS modules to operate completely independently of each other. This means that in case one UPS module needs to be removed or added to the system, this can be managed fast and seamlessly. The DPA 250 S4 has a very robust design and features strong and practical handles. It is only possible to insert modules into the rack in the correct orientation and the slide rails have mechanical stoppers to stop the module from sliding out too far, thus preventing an unintentional drop.

High efficiency reduces total cost of ownership (TCO)



Featuring superior 97.6 percent UPS module efficiency and 97.4 percent system efficiency,

the DPA 250 S4 reduces energy losses that create pure costs as direct electricity spend and costs for cooling. Thanks to three-level interleaved technology, the DPA 250 S4 achieves an efficiency of over 97 percent in a wide operating range, when the load is between 25 and 75 percent of nominal capacity



Xtra VFI – double conversion mode maximizes efficiency under low-load conditions

Under operating conditions where the load is low compared to UPS total capacity, efficiency typically suffers, and relative power losses are increased. Under these conditions, by using ABB's intelligent Xtra VFI – double conversion mode, the DPA 250 S4 can step up the system efficiency by optimizing the number of modules used in double conversion mode to feed the load. In the case of a load step, more modules are switched automatically in milliseconds to online mode to secure the critical load

1.1-1: DPA 250 S4 efficiency graph

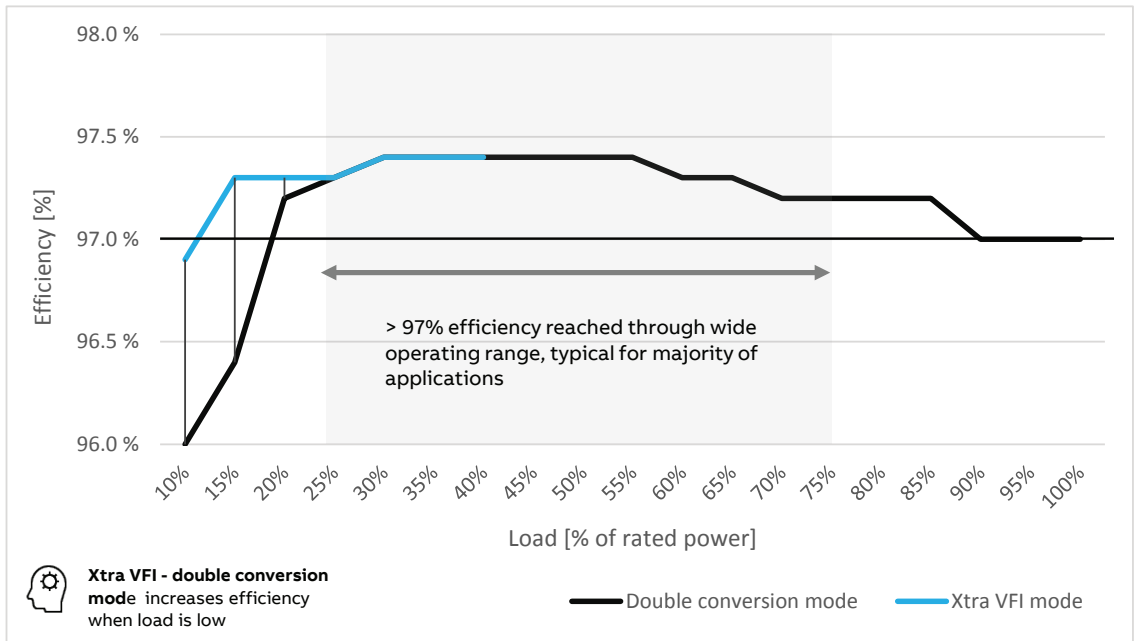

1.1-1

Image above illustrates actual measured efficiency of DPA 250 S4 - 250 kW UPS solution. Superior double conversion efficiency helps to decrease costs for operation. The Xtra VFI feature boosts efficiency when the UPS operates with low load compared to nominal capacity

Meet a variety of installation schemes and fast service



Adaptable to different installation schemes

The DPA 250 S4 can be wired to have separate or common input feeds to the rectifier and static by-pass. The wiring scheme is easy to change on-site before installation. Top or bottom cable entry can be chosen as factory-installed option.



< 10 min service time

The UPS modules have virtually no wiring. The circuit boards and other internal components have been positioned in such way that consumable parts that may require replacement during service life are easily extractable – making maintenance safer and faster. It takes only 10 minutes to extract a module, replace consumable parts, insert it back to the system and turn it back online.

Adaptable to variety of energy storage solution



Variety of options for energy backup, including lithium-ion batteries

The DPA 250 S4 can be installed with module-specific backup energy for highest availability – or a common battery for the whole UPS rack to optimize cost. The DPA 250 S4 is also compatible with modern lithium-ion batteries a good option for those who look for further space savings without compromise in backup time

All these factors give the DPA 250 S4 the lowest total cost of ownership of its class and help achieve the six nines availability (99.9999 per cent) that is so desirable for data centers in pursuit of zero downtime.

1.2 System identification

1.2.1-1: Bottom cable entry view

1.2.1 DPA 250 S4 250 kW (N+1) UPS frame types - Bottom cable entry

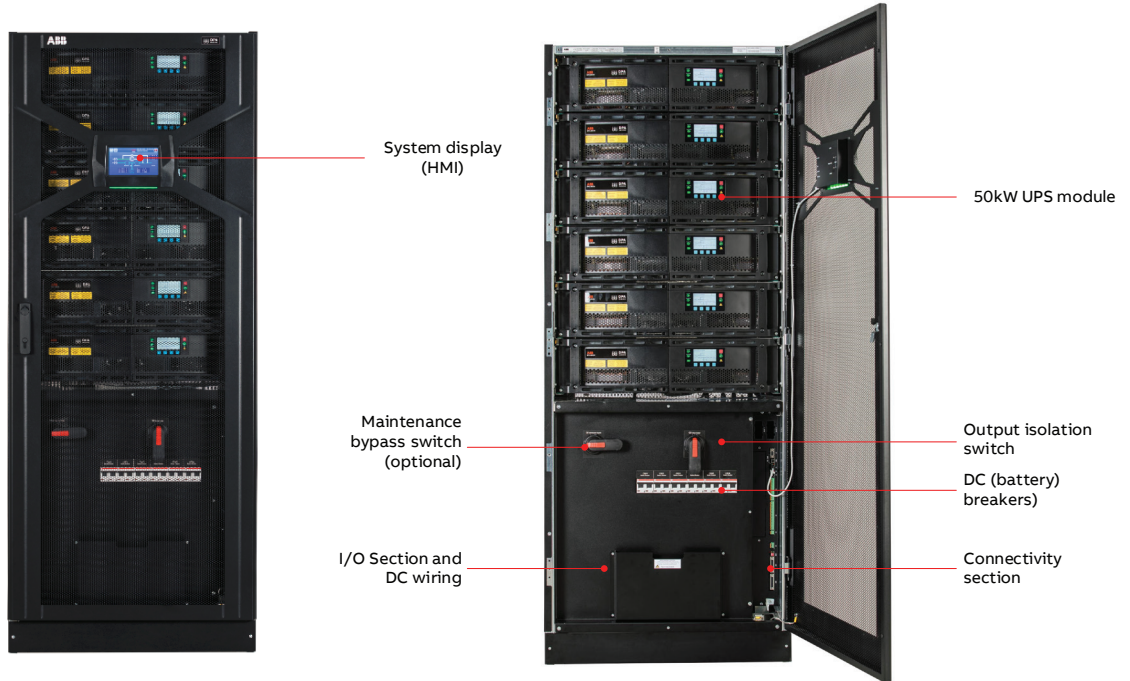

1.2.1-1

1.2.2.1 Available models

Description	Configuration
UPS DPA 250 S4 F250-6 BCE SP	UPS frame is equipped with system graphical display, parallel kit and cable, up to 6 x UPS Module slots (N+1). Suitable for parallel system configuration
UPS DPA 250 S4 F250-6 BCE P	UPS frame is equipped with parallel kit and cable, up to 6 x UPS Module slots (N+1). Suitable for parallel system configuration
UPS DPA 250 S4 F250-6 BCE S MBS	UPS frame is equipped with system graphical display, maintenance bypass switch (MBS), up to 6 x UPS Module slots (N+1). Suitable for standalone configuration

—
1.2.2-1: Top
cable entry view

1.2.2 DPA 250 S4 250 kW (N+1) UPS frame types - Top cable entry

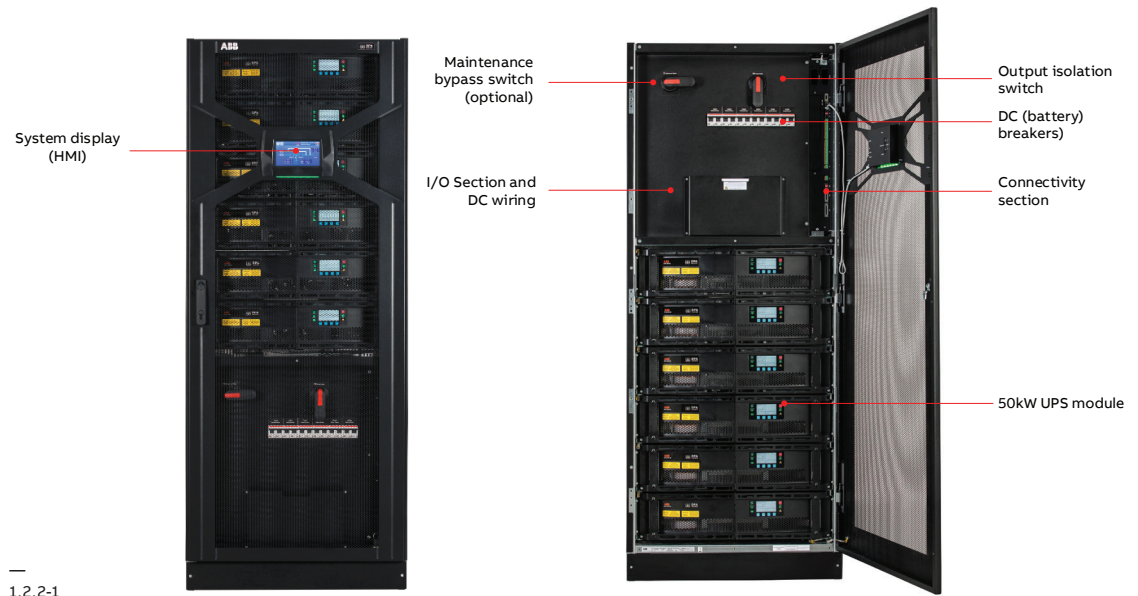

—
1.2.2-1

1.2.2.1 Available models

Description	Configuration
UPS DPA 250 S4 F250-6 TCE SP	UPS frame is equipped with system graphical display, parallel kit and cable, up to 6 x UPS Module slots (N+1). Suitable for parallel system configuration.
UPS DPA 250 S4 F250-6 TCE P	UPS frame is equipped with parallel kit and cable, , up to 6 x UPS Module slots (N+1). Suitable for parallel system configuration.
UPS DPA 250 S4 F250-6 TCE S MBS	UPS frame is equipped with system graphical display, maintenance bypass switch (MBS), up to 6 x UPS Module slots (N+1). Suitable for standalone configuration.

—
1.2.3-1: Module
block digram

1.2.3 DPA 250 S4 50 kW UPS module

The UPS module of the DPA 250 S4 is core engine of this modern, high efficiency UPS. The module includes all essential parts of a complete double conversion UPS: Rectifier, inverter, DC-converter (battery charger), static bypass switch and back-feed protection. Each module has also it's own control logic and small display for monitoring and management. This allows for the modules to be completely independent and act fully redundant with each other. Decentralized paralleling architecture (DPA™) is the most reliable modular architecture – as if having individual UPS connected in parallel, but in a single frame.

—
1.2.3-2: DPA inside label

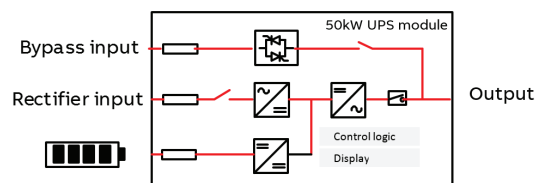

—
1.2.3-1



—
1.2.3-2

High efficiency module converters leverage three-level IGBT technology allowing for achieving 97.6% efficiency in double conversion. Compared to typical UPS with 93-96% efficiency, this means less power losses, less heat dissipation and less money spent on electricity.

1.2.3.1 Mechanical characteristics







Dimensions - height	[mm]	175
Dimensions - width	[mm]	706
Dimensions - depth	[mm]	825
Weight	[kg]	66
Ingress protection		IP20

1.2.3.2 Available models

Description	Configuration
UPS MODULE DPA250S4 M50	50kW UPS model M50

1.2.4 UPS Standalone configuration

The DPA 250 S4 250 kW frame can be equipped with up to 6 modules (N+1 configuration). In the below table, standard configurations are listed and described.

					
Number of modules					
1 x 50 kW	2 x 50 kW	3 x 50 kW	4 x 50 kW	5 x 50 kW	6 x 50 kW
Maximum load					
50 kW	100 kW	150 kW	200 kW	250 kW	250 kW
Configuration with maximum load					
N+0	N+0	N+0	N+0	N+0	N+1
Note: Depending on the actual load level system features automatic redundancy.					

Applicable for UPS models

- UPS DPA 250 S4 F250-6 BCE S MBS
- UPS DPA 250 S4 F250-6 TCE S MBS

1.2.4.1 Standard options

- System graphical display
- Top or bottom cable entry
- Single or dual input feed
- Separate or common battery/ energy storage connection
- With maintenance bypass switch
- Standard or halogen-free cables
- Cold start option (start from battery without mains input)
- Common connectivity options (please see section 5 for details)

1.2.5 Parallel system configuration

The DPA 250 S4 UPS unit can be paralleled to increase the power capacity up to 1500kW. Up to 6 UPS units with 30 UPS modules can be configured as shown in the below table:

Number of UPS units					
1 x 250 kW	2 x 250 kW	3 x 250 kW	4 x 250 kW	5 x 250 kW	6 x 250 kW
Maximum load					
250 kW	500 kW	750 kW	1000 kW	1250 kW	1500 kW
Maximum number of UPS Modules					
6	12	18	23	29	30
Configuration with maximum load					
N+1	N+1	N+1	N+1	N+1	N+0
Note: Depending on the actual load level system features automatic redundancy.					

Applicable for UPS models

- UPS DPA 250 S4 F250-6 BCE SP
- UPS DPA 250 S4 F250-6 BCE P
- UPS DPA 250 S4 F250-6 TCE SP
- UPS DPA 250 S4 F250-6 TCE P

1.2.5.1 Standard options

- System graphical display (available for SP model)
- Top or bottom cable entry
- Single or dual input feed
- Separate or common battery/ energy storage connection
- Standard or halogen-free cables
- Cold start option (start from battery without mains input)
- Common connectivity options (please see section 5 for details)

1.3 Mechanical and safety characteristics

*
Conditions apply

**
Available by different frame models. Configuration cannot be changed at installation site

NUMBER OF MODULES		1	2	3	4	5	6
Dimensions - height	[mm]	1978					
Dimensions - width	[mm]	795					
Dimensions - depth	[mm]	943					
Mass	[kg]	345	409	474	538	603	667
Acoustic noise at 1 m: - Normal mode @ 50% load	[dBA]	<65dB					
Access (operator access or restricted access)		Operator access area					
Degree of protection against hazards and water ingress		IP 20					
Service access		Front service access*					
Cable entry		Top or bottom cable entry**					
UPS frame cabinet color		Black (RAL9005)					

1.4 Electromagnetic compatibility

Emission	[Cat]	C3
Immunity	[Cat]	C3

1.5 Environmental characteristics

Ambient operating temperature range	[°C]	0-40 °C
Relative humidity range	[%]	≤ 95% (non-condensing)
Altitude without de-rating	[m]	1000 m
Ambient storage temperature range	[°C]	-25... 70 °C ¹

¹ Elevated storage temperatures may impact useful life, specifically for the UPS capacitors. Ideal storage temperature is between +5 and +35 °C and at relative humidity of up to 75%. Long term storage in an environment with high humidity should be avoided. Likewise, one should avoid storage in environments that contain halogenated gases (and other hazardous gases), sprinkling water or oil as well as exposure any radiation.

2 Input electrical characteristics

2.1 Input AC power distribution system

Input AC power distribution system compatibility (earthing system)		TN-S, TN-C, TN-C-S, TT
Input AC power distribution system wiring		3ph + neutral + PE
Input rated short-time withstand current (I_{cw})	[kA, s]	10 kA, 1.5 s
Input AC power distribution system wiring		3 ph + N + PE
Additional information		Single or dual input feed for rectifier and bypass

2.2 Input voltage and frequency

Input rated voltage	[V]	380, 400 or 415 V ph-ph 220, 230 or 240 V ph-N
Input voltage tolerance Applicable for 400V nominal voltage	[%]	Load ≤ 100% (-10%, +15%) Load ≤ 80% (-20%, +15%) Load ≤ 60% (-30%, +15%)
Input rated frequency	[Hz]	50 or 60
Input frequency tolerance	[Hz]	35-70

2.3 Input current and overload characteristics

NUMBER OF MODULES		1	2	3	4	5	6
Input rated current (with energy storage device charged) - 380 / 400 / 415 V configuration	[A]	78	157	235	314	392	392
		74	149	223	298	372	372
		72	144	215	287	359	359
Input maximum current (with low input voltage and/or energy storage device charging)	[A]	87.4	175.8	263.2	351.7	439.0	478.2
Total harmonic distortion, 100 % load -normal mode - linear load (at 400V input voltage; input THDU < 2%; tolerance of ±0.3% may apply)	[%]	< 3%					
Total harmonic distortion, 100 % load -normal mode - non-linear load (at 400V input voltage; input THDU < 2%; tolerance of ±0.3% may apply)	[%]	< 4%					
Rectifier input in-rush (% of rated current against time)	[% , s]	< 100 % of rated current					
Rectifier input power factor (rated linear load; rated non-linear load)		0.99 at 100% rated load					

3 Output electrical characteristics

Output AC power distribution system compatibility (earthing system)		TN-S, TN-C, TN-C-S, TT
Output AC power distribution system wiring		3ph + neutral + PE
OUTPUT VOLTAGE		
Output rated voltage	[V]	380, 400 or 415 V ph-ph 220, 230 or 240 V ph-N
Output voltage variation - normal mode	[%]	± 1 %
Output voltage variation - stored energy mode	[%]	± 1 %
Total harmonic distortion, 100 % load -normal mode - rated load	[%]	<2
Voltage unbalance and phase displacement, 100 % load unbalance	[% , °]	1 %, < 1°
Voltage transient and recovery time		
Voltage transient and recovery time - 100 % step load - linear	[% , s]	<4%, (<2s)
Voltage transient and recovery time - 100 % step load - non-linear	[% , s]	<4%, (<2s)
Voltage transient and recovery time - transfer normal mode / storage energy mode	[% , s]	<1%, (<2s)
THDu normal mode - Linear	[%]	<2.0% @ 100% load
THDu normal mode - Non-linear	[%]	<4.0% @ 100% load
THDu battery mode - Linear	[%]	<2.0% @ 100% load
THDu battery mode -Non-linear	[%]	<4.0% @ 100% load
OUTPUT FREQUENCY		
Output rated frequency	[Hz]	50 or 60 Hz
Output frequency variation - normal mode	[%]	± 2% or 4% selectable (synchronized with mains, allowing for transfer to static bypass)
Output frequency variation - stored energy mode	[%]	± 0.1%
Output frequency variation - free-running	[%]	± 0.1%
Synchronization (max ± % range of rated frequency)	[%]	± 2% or 4% selectable

Max synch. phase error (referred to a 360° cycle)	[°]	2					
OUTPUT CURRENT							
Number of modules		1	2	3	4	5	6
Output rated current (380 / 400 / 415 V configuration)	[A]	76 72 69	151 144 139	227 216 208	303 288 278	379 360 347	400 394 379
Output overload (% of rated current / time duration) at 40°C, 380/400/415 V rated voltage	[% / s]	150% 1min 125% 10 min 110% continuous					
Output current limitation, "short circuit current" (% of rated current / time duration, 400V rated voltage)	[% / s]	2.9 x In, 100 ms 3.2 x In 40ms					
	[A]	231	462	693	924	1155	1386
Fault clearing capability (normal mode / stored energy mode)	A gL fuse	20	40	63	80	100	125
POWER FACTOR							
Load power factor - rated		1.0					
Load power factor - displacement (permissible lead-lag range)		0.7 lag to 0.9 lead					
EFFICIENCY							
Double conversion efficiency - 100% rated load	[%]	96.9	96.9	96.9	96.9	96.9	97.2
Double conversion efficiency - 75% rated load	[%]	97.3	97.3	97.3	97.3	97.2	97.3
Double conversion efficiency - 50% rated load	[%]	97.4	97.4	97.4	97.4	97.4	97.4
Double conversion efficiency - 25% rated load	[%]	97.3	97.3	97.3	97.3	97.3	97.2
STATIC BYPASS SWITCH							
Static bypass switch		Yes, UPS module integrated					
Rated current	[A]	76	152	228	304	380	380
Bypass overload (% of rated current / time duration)	[% / s]	110% continuous 140% 10 min 190% 2 min >190% 10s					
Bypass voltage tolerance (% of rated voltage @ 400V)	[%]	-20 % +15%					
Bypass fault clearing capability (% of rated current / time duration @ 400V)	[% / s]	10 In / 20 ms					
Bypass protection fuse or circuit breaker rating	[A]	80					
MAINTENANCE BYPASS SWITCH		Frame integrated, available as option					

4 Battery and energy storage

Energy storage type		No integrated batteries, external energy storage needed. Line-and-match cabinets available as accessory					
Technology		Lithium ion, VRLA, NiCd					
Design life or float service life		Ref to battery manufacturer provided information					
Quantity of cells and strings	[pcs]	LIB (Samsung SDI): 17 modules / 136 cells. VRLA 12V: 40-50 blocks/ 240-300 cells per string					
Nominal voltage (total)	[Vdc]	480 V - 600 V					
Nominal Ah capacity (C10)		Battery type dependent.					
Stored energy time (back-up time at 100 % rated load)	[min]	Up to X min without de-rate; may depend on battery type.					
Restored energy time (re-charge time to 90 % capacity)	[h]	10					
Ambient reference temperature	[°C]	Battery type dependent. For VRLA, 20-25 For LIB, 18-28°C recommended to secure maximal service life					
Nominal discharge current	[A d.c.]	100	200	300	400	500	500
Fault current rating	[A d.c.]	5kA					
CHARGING REGIME							
Charge voltage (float, boost) and tolerance band	[V d.c.]	2.23 V/Cell VLRA 1.40 V/Cell NiCd					
End of discharge voltage	[V d.c.]	1.68V/Cell VLRA 1.05V/Cell Ni-Cd					
Charge current limit (or range)	[A d.c.]	38	76	114	152	190	228
Charge power limit	[kW]	15	30	45	60	75	90
Battery ripple current max.	[A]	400mA RMS					
ADDITIONAL INFORMATION							
Cable voltage drop recommendation		1%					
Battery temperature compensation		Supported by standard UPS. Temperature sensor available as option					
Battery test		Automatic battery test performed by UPS					

Lithium-ion battery values indicated in table above are valid just for Samsung SDI product.

5 Control & Monitoring

5.1 System display

5.1-1: System display

The UPS system has a system graphical display. It is a 7" touchscreen display enabling the operator to perform:

- Monitoring and measuring of the power flow through the UPS system, individual UPS modules and batteries.

- Monitoring of UPS operational status, events and alarm history
- UPS setting configuration
- UPS Data

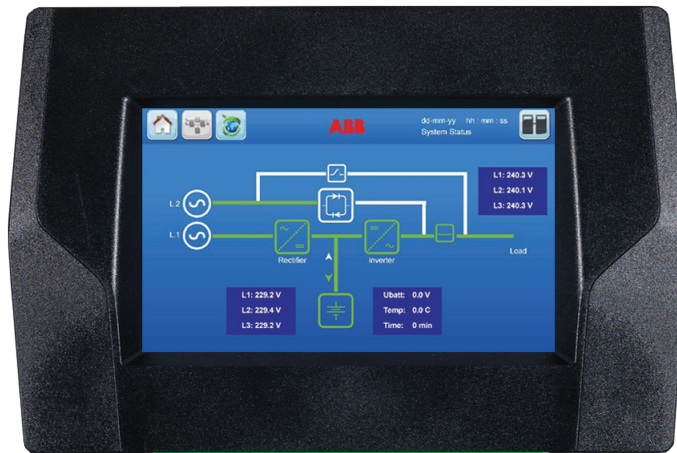

5.1-1

5.2 Control panel UPS Module

5.2-1: Control panel UPS module

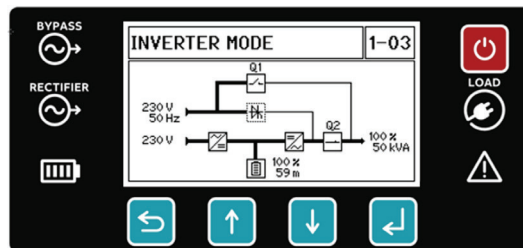

5.2-1

The UPS module has its own control panel consisting of an LCD display, control and navigation buttons and led status indicators. The LCD display shall display :

- Mimic diagram of the UPS module showing the rectifier, battery, static bypass, inverter status and the input, bypass, battery and output measurements : voltage, frequency, power
- UPS module status: module off, module disconnected, inverter mode, bypass mode, battery mode, stand-by mode
- UPS module location : UPS frame and module number

control panel is not in use. The screensaver mode is deactivated if any control button is pressed or alarm popup.

The control and navigation buttons shall allow the user to perform settings and adjustments, monitor the voltages, currents, frequencies, power measurements and scroll the main and sub-menus in the UPS module.

The user shall be able to identify the status of the bypass, rectifier, battery and UPS output and the alarm by reading the LED indicators. The LEDs are always active even if the display is in screensaver mode. Please refer to the OPM for more information











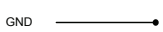
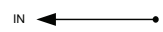

The LCD display goes into "Screensaver mode" by turning off the screen after 5 minutes if the con-

5.3 Communication interfaces

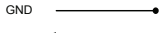
5.3.1 Input dry ports (X3)

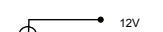
X1-X3 can hold Cable from 0.2mm² – 1.5mm²

All X3 (except X3 5/6 which is a 12VDC source) are inputs, cable max. R 50Ω at 20mA

Block	Terminal	Contact	Signal	On Display	Function
X3	X3 / 14		GND		Battery Temperature (Only the optional battery sensor from ABB is compatible)
	X3 / 13		+3.3VDC		
	X3 / 12		GND	GENERATOR_ OPER_ON	Generator Operation (N.O.) Min. contact load 12V / 1mA
	X3 / 11		+12Vdc		
	X3 / 10		GND	PARRALEL_SW_OPEN PARRALEL_SW_CLOSE	External Output Breaker (N.O.) Min. contact load 12V / 20mA.
	X3 / 9		+12Vdc		
	X3 / 8		GND	EXT_MAN_BYP	External Manual Bypass (N.O.) Min. contact load 20mA
	X3 / 7		+12Vdc		
	X3 / 6		+12Vdc		+ 12 VDC source (UPS protected) (Max. 200mA)
	X3 / 5		GND		
	X3 / 4		GND	REMOTE_ SHUTDOWN	RSD (Remote Shut down) Default setting: disabled. Possibility to enable and set NO or NC via NewSet.
	X3 / 3		+12Vdc		
	X3 / 2		-	REMOTE_ SHUTDOWN	RSD (Remote Shut down) for external switch Max. 250Vac/8A ;30Vdc/8A; 110Vdc/0.3A ;220Vdc/0.12A
	X3 / 1		-		

5.3.2 Output dry port (X2 and X1)

X2 terminals can hold Cable from 0.2mm² – 1.5mm²

X2 are potential free contacts and are rated: Max 250Vac/8A; 30Vdc/8A; 220Vdc/0.12A

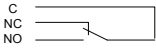
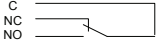
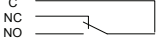
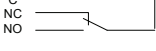
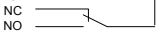
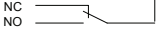
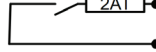
Block	Terminal	Contact	Signal	On Display	Function
X2	X2 / 18		-		Common
	X2 / 17		-		Relais AUX (Function on request, to be defined)
	X2 / 16		-		
	X2 / 15			COMMON_ALARM	Common
	X2 / 14		ALARM		No Alarm Condition
	X2 / 13				Common Alarm (System)
	X2 / 12			LOAD_ON_MAINS	Common
	X2 / 11		Message		No Load on Bypass
	X2 / 10				Load On Bypass (Mains)
	X2 / 9			BATT_LOW	Common
	X2 / 8		ALARM		Battery Ok
	X2 / 7				Battery Low
	X2 / 6			LOAD_ON_INV	Common
	X2 / 5		Message		No Load on Inverter
	X2 / 4				Load on Inverter
	X2 / 3			MAINS_OK	Common
	X2 / 2		ALARM		Mains Failure
X2 / 1				Mains Present	
X1	X1 / 2		-	EXT_MAN_BYP	Interlock Function Max. 30Vdc/2A; 60Vdc/0.7A (Ext Manual Bypass) / 2AT
	X1 / 1		-		

5.3.3 Network Management cards (option)

ABB DPA 250 S4 can be equipped with network management cards to connect ABB UPS system to the building management systems. The network interface card provides:

- Remote UPS monitoring via Web
- UPS event log records

Following protocols are offered :

- SNMP
- Modbus TCP/IP
- Modbus RS-485

6 Options and accessories

ARTICLE	DESCRIPTION	DETAIL
Product options or features – electronics & software		
00-6022	Parallel cable kit 10m	
00-8685	Parallel cable kit 15m	
00-8686	Parallel cable kit 20m	
00-8687	Parallel cable kit 25m	
4NWP104095R0004	Elevation kit	
Product options or features – external batteries		
00-3563	Temperature probe for batteries	Cable length 1.3m.
Packaging		
4NWP103846R0001	Carton packaging for one DPA 250 S4 module	
4NWP101978R0001	Light sea freight packaging DPA 250 S4 frame	
4NWP101978R0001	Sea freight packaging DPA 250 S4 frame	
Documentation		
00-2976	Certificate of origin	Legalized invoice is also available.
04-0160	Duplicate of the commissioning report	
04-0161	Duplicate of archived commissioning rep.	
Other		
4NWP104096R0001	12 months extra warranty for 1 DPA 250 S4 module	Available for 50kW modules

7 Site planning information

7.1 Installation footprint and clearances

7.1-1: DPA 250 S4 clearances

The minimum needed clearances to allow proper airflow on the UPS system and to allow proper service and maintenance shall be respected as reported below:

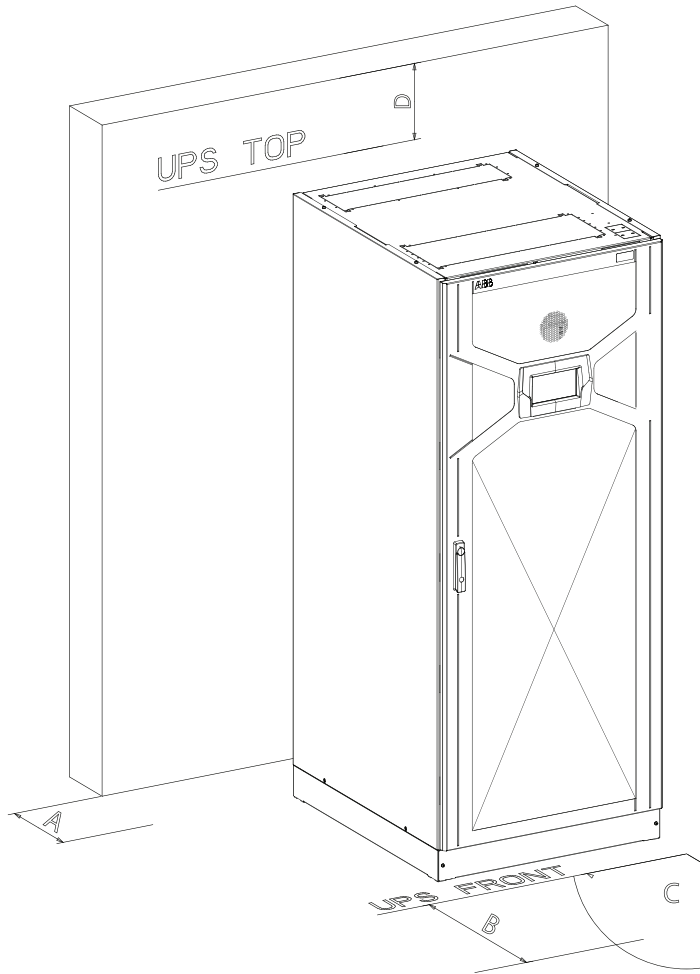

7.1-1

		SINGLE DPA 250 S4 FRAME	UPS PARALLEL SYSTEM SIDE BY SIDE INSTALLATION OR BATTERY CABINETS IN ROW.
A	Back clearance for ventilation (forced air outlet)	200 mm	300 mm
B	Front clearance needed to allow a correct door opening	1000 mm	
C	Maximum door opening angle	115°	
D	Top Clearance (Top clearance is only needed if there is no side clearance)	400 mm	

7.2 Single line diagrams for common configurations

The DPA 250 S4 250 kW frame can support different type of installation and wiring schemes. The configuration should be selected according to the site installation needs and restrictions. In this section common configurations are presented with recommended AC and DC cable and fuse selections.

7.2.1 Single input feed and common battery (default)

7.2.1-1: Single input feed and common battery block diagram

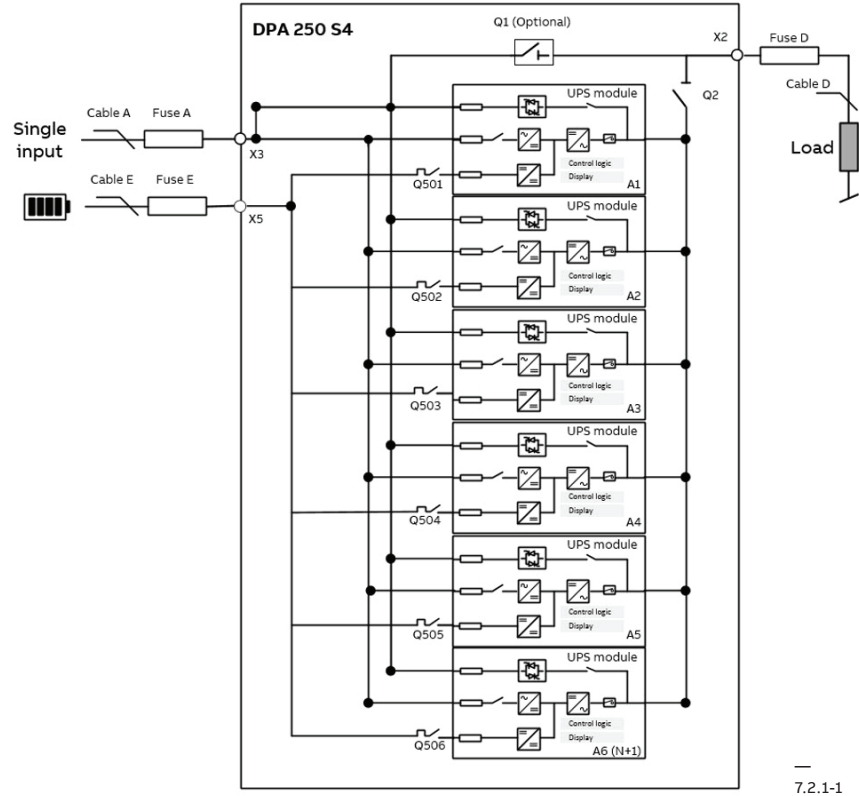

Following external protection and cable sizes are recommended per UPS power rating

UPS POWER RATING	kW	50	100	150	200	250
Rectifier input fuse [Fuse A] gL or CB C curve, 3P	A	100	200	315	400	500
Rectifier input cable section (L1,L2,L3,N) [Cable A]	mm ²	4x35	4x95	4x(2x50)	4x(2x95)	4x(2x120)
Rectifier input cable section (PE)	mm ²	16	50	50	95	120
UPS output fuse [Fuse D] gL or CB C curve, 4P	A	100	200	315	400	500
Output cable section (L1,L2,L3,N) [Cable D]	mm ²	4x35	4x95	4x(2x50)	4x(2x95)	4x(2x120)
Output cable section (PE)	mm ²	16	50	50	95	120
Battery input fuse [Fuse E]	A	125	250	400	500	630
Battery cable section (+,-) [Cable E]	mm ²	2x50	2x120	2x(2x95)	2x(2x120)	2x(2x150)
Battery PE cable section	mm ²	25	70	95	120	150

7.2.2-1: Single input feed and separate battery block diagram

7.2.2 Single input feed and separate battery

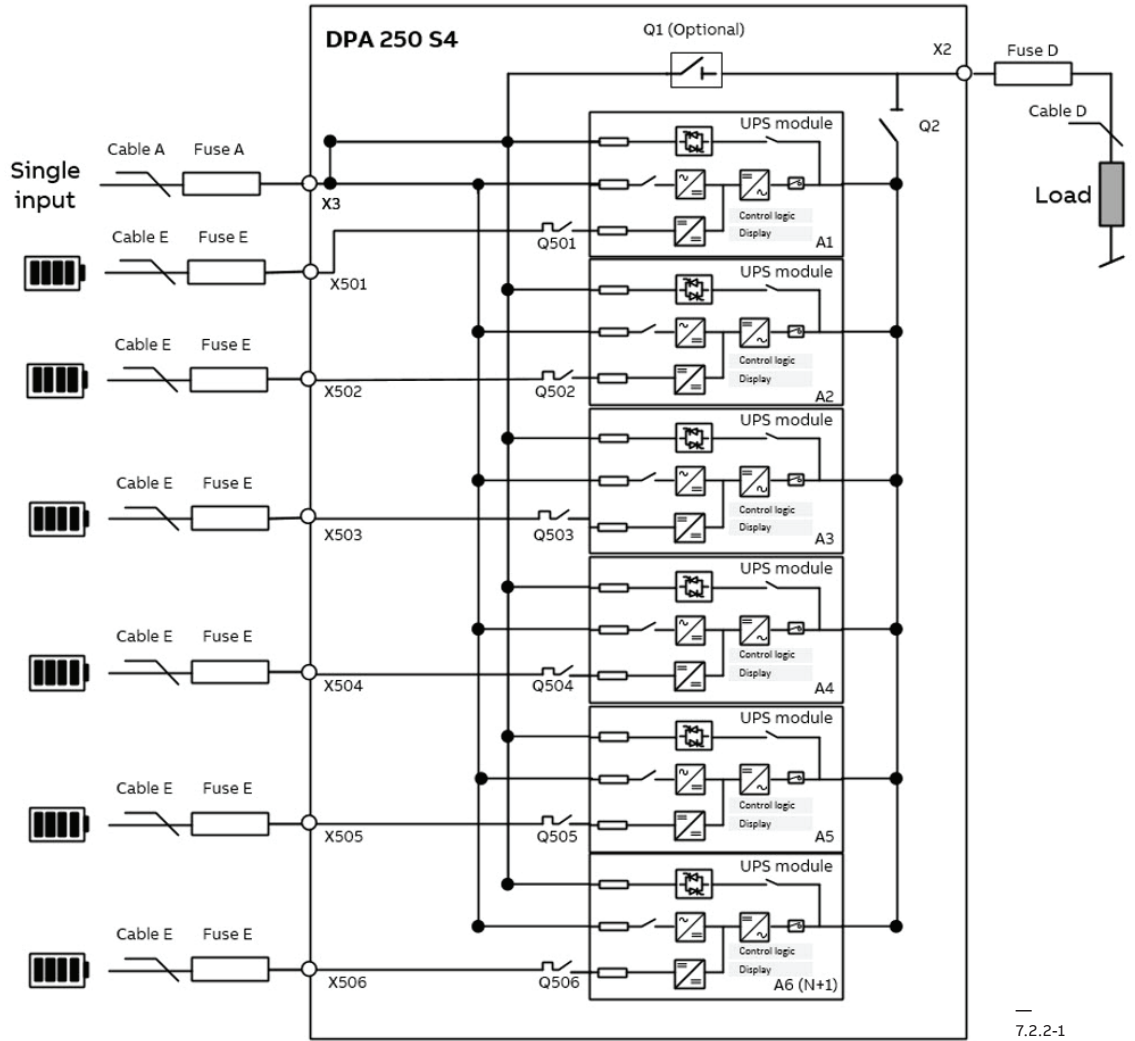

7.2.2-1

Following external protection and cable sizes are recommended per UPS power rating

UPS POWER RATING	kW	50	100	150	200	250
Rectifier input fuse [Fuse A] gL or CB C curve, 3P	A	100	200	315	400	500
Rectifier input cable section (L1,L2,L3,N) [Cable A]	mm2	4x35	4x95	4x(2x50)	4x(2x95)	4x(2x120)
Rectifier input cable section (PE)	mm2	16	50	50	95	120
UPS output fuse [Fuse D] gL or CB C curve, 4P	A	100	200	315	400	500
Output cable section (L1,L2,L3,N) [Cable D]	mm2	4x35	4x95	4x(2x50)	4x(2x95)	4x(2x120)
Output cable section (PE)	mm2	16	50	50	95	120
Battery input fuse [Fuse E]	A	125	125	125	125	125
Battery cable section (+,-) [Cable E]	mm2	2x50	2x50	2x50	2x50	2x50
Battery PE cable section	mm2	25	25	25	25	25

7.2.3-1: Dual input feed and common battery block diagram

7.2.3 Dual input feed and common battery

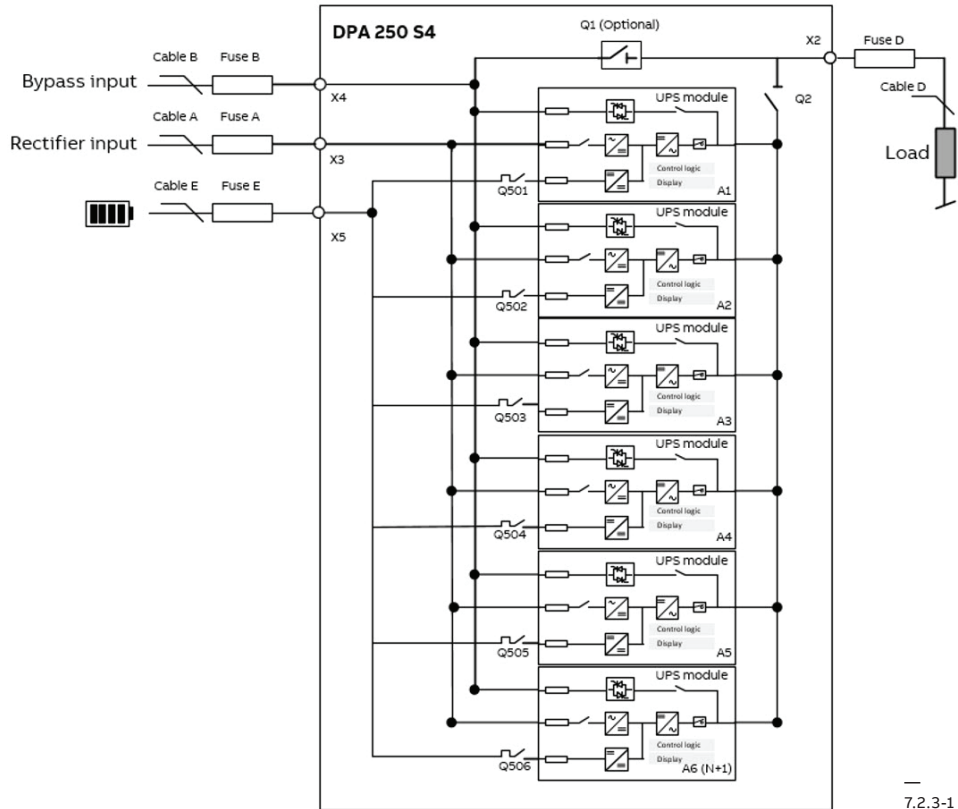

7.2.3-1

Following external protection and cable sizes are recommended per UPS power rating

UPS POWER RATING	kW	50	100	150	200	250
Rectifier input fuse [Fuse A] gL or CB C curve, 3P	A	100	200	315	400	500
Rectifier input cable section (L1,L2,L3,N) [Cable A]	mm2	4x35	4x95	4x(2x50)	4x(2x95)	4x(2x120)
Rectifier input cable section (PE)	mm2	16	50	50	95	120
Bypass input fuse [Fuse B] gL or CB C curve, 3P	A	100	200	315	400	500
Bypass input cable section(L1,L2,L3,N) [Cable B]	mm2	4x35	4x95	4x(2x50)	4x(2x95)	4x(2x120)
Bypass input cable section (PE)	mm2	16	50	50	95	120
UPS output fuse gL or CB C curve, 4P [Fuse D]	A	100	200	315	400	500
Output cable section (L1,L2,L3,N) [Cable D]	mm2	4x35	4x95	4x(2x50)	4x(2x95)	4x(2x120)
Output cable section (PE)	mm2	16	50	50	95	120
Battery input fuse [Fuse E]	A	125	250	400	500	630
Battery cable section (+,-) [Cable E]	mm2	2x50	2x120	2x(2x95)	2x(2x120)	2x(2x150)
Battery PE cable section	mm2	25	70	95	120	150

7.2.4-1: Dual input feed and separate battery block diagram

7.2.4 Dual input feed and separate battery

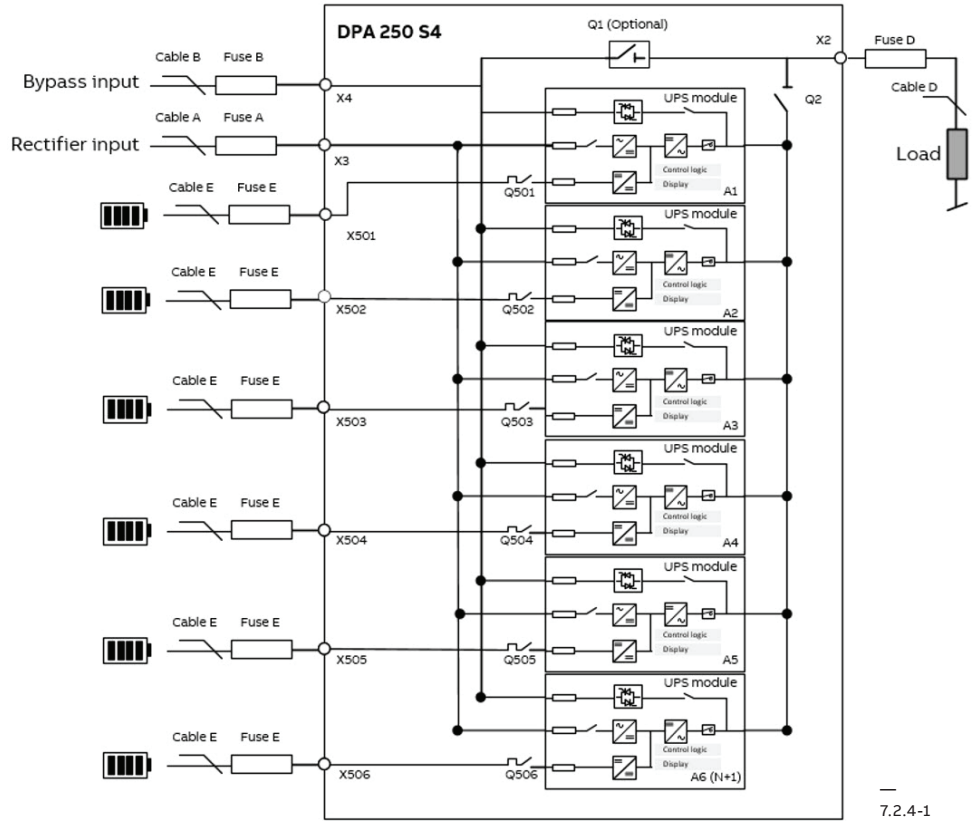

Following external protection and cable sizes are recommended per UPS power rating

UPS POWER RATING	kW	50	100	150	200	250
Rectifier input fuse [Fuse A] gL or CB C curve, 3P	A	100	200	315	400	500
Rectifier input cable section (L1,L2,L3,N) [Cable A]	mm2	4x35	4x95	4x(2x50)	4x(2x95)	4x(2x120)
Rectifier input cable section (PE)	mm2	16	50	50	95	120
Bypass input fuse [Fuse B] gL or CB C curve, 3P	A	100	200	315	400	500
Bypass input cable section(L1,L2,L3,N) [Cable B]	mm2	4x35	4x95	4x(2x50)	4x(2x95)	4x(2x120)
Bypass input cable section (PE)	mm2	16	50	50	95	120
UPS output fuse gL or CB C curve, 4P [Fuse D]	A	100	200	315	400	500
Output cable section (L1,L2,L3,N) [Cable D]	mm2	4x35	4x95	4x(2x50)	4x(2x95)	4x(2x120)
Output cable section (PE)	mm2	16	50	50	95	120
Battery input fuse [Fuse E]	A	125	125	125	125	125
Battery cable section (+,-) [Cable E]	mm2	2x50	2x50	2x50	2x50	2x50
Battery PE cable section	mm2	25	25	25	25	25

7.3 UPS terminal sizes

LABEL	CABLE SIZE	TORQUE (Nm)	TERMINALS DESCRIPTION
X3.1: L1	M12 Bolt Terminal	50-75	Input Line L1
X3.2: L2	M12 Bolt Terminal	50-75	Input Line L2
X3.3: L3	M12 Bolt Terminal	50-75	Input Line L3
X6: N	M12 Bolt Terminal	50-75	Neutral bar (N) [Common neutral]
X7: PE	M6 Bolt Terminal	6	Earth bar (PE) [Common earth]
X4.1: L1	M12 Bolt Terminal	50-75	Bypass Line L1
X4.2: L2	M12 Bolt Terminal	50-75	Bypass Line L2
X4.3: L3	M12 Bolt Terminal	50-75	Bypass Line L3
X2.1: L1	M12 Bolt Terminal	50-75	Output terminal, L1
X2.2: L2	M12 Bolt Terminal	50-75	Output terminal, L2
X2.3: L3	M12 Bolt Terminal	50-75	Output terminal, L3
X5.1: +	M6 Bolt Terminal	50-75	Battery Terminal, +
X5.2: -	M6 Bolt Terminal	50-75	Battery Terminal, -

7.4 Heat dissipation

NR. MODULES		50kW N+0	100kW N+0	150kW N+0	200kW N+0	250kW N+0	250kW N+1
Heat Dissipation with 100% Non-linear Load per Module (EN 62040-1-1)	[W]	2100	4200	6300	8400	10500	9875
Heat Dissipation with 100% Non-linear Load per Module (EN 62040-1-1)	[BTU]	7165	14330	21495	28660	35826	33693
Airflow (25° - 30°C) with Non-linear Load per Module (EN 62040-1-1)	[m ³ /h]	460	920	1380	1840	2300	2210
Heat dissipation without load	[W]	160	320	480	640	800	960

www.abb.com/ups
ups.sales@ch.abb.com

