

# PowerWave 33 60 - 500 kW

## Technical Specifications



**TABLE OF CONTENTS**

- 10.1 POWERWAVE 33 SYSTEM DESCRIPTION .....3**
- 10.2 TECHNICAL CHARACTERISTICS .....4**
  - 10.2.1 MECHANICAL CHARACTERISTICS POWERWAVE 33 60-100kW .....4
  - 10.2.2 MECHANICAL CHARACTERISTICS POWERWAVE 33 120-200kW .....5
  - 10.2.3 MECHANICAL CHARACTERISTICS POWERWAVE 33 250-300kW .....6
  - 10.2.4 MECHANICAL CHARACTERISTICS POWERWAVE 33 400-500kW .....6
- 10.3 INPUT CHARACTERISTICS .....7**
  - 10.3.1 GRAPH: INPUT PF VERSUS % LOAD.....8
  - 10.3.2 GRAPH: INPUT DISTORTION THDi VERSUS % LOAD.....8
- 10.4 BATTERY CHARACTERISTICS .....9**
- 10.5 OUTPUT CHARACTERISTICS .....9**
  - 10.5.1 GRAPH: AC – AC EFFICIENCY with Linear load @  $\cos\phi$  1 .....10
  - 10.5.2 GRAPH: Output Power in KW and KVA VERSUS  $\cos\phi$   $V_{out}=230V_{ac}$  rms line to neutral, 50Hz,  $\geq$  44 battery blocks .....10
- 10.6 ENVIRONMENTAL CHARACTERISTICS .....11**
- 10.7 STANDARDS .....11**
- 10.8 COMMUNICATION .....12**
  - 10.8.1 POWER MANAGEMENT DISPLAY (PMD).....13
  - 10.8.2 MIMIC DIAGRAM.....13
  - 10.8.3 DISPLAY .....13
  - 10.8.4 CUSTOMER INTERFACES (PW33 60-300 kW).....14
  - 10.8.5 CUSTOMER INPUTS DRY PORTs: Terminal block X1 .....14
  - 10.8.6 CUSTOMER OUTPUTS DRY PORTs : Terminal blocks X2.....14
  - 10.8.7 CUSTOMER INTERFACES (PW33 400-500 kW).....14
  - 10.8.8 CUSTOMER INPUTS DRY PORTs: Terminal blocks X3 / 3-14.....14
  - 10.8.9 OUTPUTS DRY PORTs: Terminal blocks X2 + X3 / 1-2.....14
  - 10.8.10 INTERLOCK CASTELL FUNCTION: Terminal block X1.....14
- 10.9 OPTIONS .....16**
  - 10.9.1 SNMP card / WaveMon Management Software .....16
  - 10.9.2 Battery Enclosures.....17
  - 10.9.3 Top Cable Entry Enclosure (TCE) .....18
- 10.10 BATTERY AUTONOMIES .....18**
  - 10.10.1 EXAMPLES OF BATTERY AUTONOMY AT FULL LOAD WITH STANDARD BATTERY CABINETS AND STANDARD BATTERY CONFIGURATION .....18
- 10.11 INSTALLATION PLANNING .....19**
  - 10.11.1 MAXIMUM HEAT DISSIPATION PER UPS RANGE WITH NON-LINEAR LOAD.....20
- 10.12 WIRING AND BLOCK DIAGRAMS FOR ALL UPS FRAMES .....21**
  - 10.12.1 TERMINAL CONNECTIONS OVERVIEW .....21
  - 10.12.2 INPUT FEED RATINGS POWERWAVE 33 60-300kW .....23
  - 10.12.3 INPUT FEED RATINGS POWERWAVE 33 400-500kW .....24

**10.1 POWERWAVE 33 SYSTEM DESCRIPTION**

In environments that demand zero downtime, continuous power protection availability is essential. In order to respond to today’s dynamic IT and process-related environments that experience daily change through new server technologies, migration and centralization, resilient and easily adaptable power protection concepts are required. POWERWAVE 33 is the foundation for continuous power protection availability of network-critical infrastructures in enterprise data centers where business continuity has paramount importance and in process control environment where manufacturing continuity is essential.

POWERWAVE 33 is an advanced double conversion UPS, VFI (Voltage and Frequency Independent) topology that responds fully to both highest availability and environmentally friendly requirements compliant with IEC 62040-3 (VFI-SS-111) standards.

The POWERWAVE 33 UPS features innovations that combine to deliver the industry’s best key values like: enhanced power performance, parallel capability and connectivity’s interaction

Decentralized Parallel Architecture is based on stacking independent UPSs for power capacity increase or for redundancy purpose for power availability increase. When operating in parallel configuration, each POWERWAVE 33 can take the leadership role avoiding single points of failure in the parallel chain ensuring the highest level of power availability.

The most demanding Data Centres starts with low power before achieving its full capacity. It is in this case essential to be able to recover the missing power requirement without risk for the applied load. POWERWAVE 33 allows for system upgrades to meet the highest level of availability interruption free and without a temporary transfer the load to row mains (by-pass).

This Technical Specification provides detailed technical information on the mechanical, electrical and environmental performance of the POWERWAVE 33 that can support to give answers to tender and end-user requirements. The POWERWAVE 33 was designed to respond to the most stringent safety, EMC and other important UPS standards.


POWERWAVE 33 is a stand-alone UPS which can be paralleled for power protection increase and/or for redundancy purpose. It offers 8 different power ranges: 60-80-100-120-160-200-250-300-400-500kW . Up to 10 UPS can be paralleled together to achieving the maximum power capacity of 5000kW using common or separate battery configuration.


**Key Features of POWERWAVE 33:**

- Best in class efficiency, **up to 96%** *Energy-Operational cost savings (TCO)*
- Compact size, Small Footprint *Space-saving of expensive floor space*
- Blade-server-friendly power Full active power from 0.9 lead to 0.9 lag *No de-rating with leading PF loads*
- Very low input current distortion THDi THDi = < 3.5 – 4 % @ 100% load, depending on the power range *Gen-set power and installation cost saving*
- Input Power Factor near unity *Cost savings during installation and the entire lifecycle (TCO)*

<b>10.2 TECHNICAL CHARACTERISTICS</b>
---------------------------------------

**10.2.1 MECHANICAL CHARACTERISTICS POWERWAVE 33 60-100kW**

<b>POWERWAVE 33 without battery enclosure</b>				
				
Power range	kW	60	80	100
Dimensions (WxHxD)	mm	550x1820x750		
Dimensions with elevation kit (WxHxD)	mm	550x1975x750		
Weight	kg	205	225	230
Colour	Graphite grey (RAL 7024)			

<b>POWERWAVE 33 with Battery Enclosure A</b>				
				
Max. Power connection	kW	60	80	100
Dimensions (WxHxD)	mm	970x1820x750		
Weight without battery	kg	250	260	285
Weight with battery with 80 block of 28Ah	kg	1140	1150	1175
Colour	Graffito grey (RAL 7024)			




Max. Power connection	kW	60	80	100
Dimensions (WxHxD)	mm	1180x1820x750		
Weight without battery	kg	260	270	295
Weight with battery with 120 block of 28Ah	kg	1590	1600	1625
Colour		Graphite grey (RAL 7024)		

**10.2.2 MECHANICAL CHARACTERISTICS POWERWAVE 33 120-200kW**




Max. Power connection	kW	120	160	200
Dimensions (WxHxD)	mm	850x1820x750		
Dimensions with elevation kit (WxHxD)	mm	850x1975x750		
Weight	kg	280	290	310
Colour		Graphite grey (RAL 7024)		

**10.2.3 MECHANICAL CHARACTERISTICS POWERWAVE 33 250-300kW**

<b>POWERWAVE 33</b>			
			
Max. Power connection	kW	250	300
Dimensions (WxHxD)	mm	1100x1920x750	
Dimensions with elevation kit (WxHxD)	mm	1100x1975x750	
Weight	kg	390	410
Colour		Graphite grey (RAL 7024)	

**10.2.4 MECHANICAL CHARACTERISTICS POWERWAVE 33 400-500kW**

<b>POWERWAVE 33</b>			
			
Max. Power connection	kW	400	500
Dimensions (WxHxD)	mm	1650x1994x850	
Dimensions with elevation kit (WxHxD)	mm	1650x2094x850	
Weight	kg	950	1000
Colour		Graphite grey (RAL 7024)	



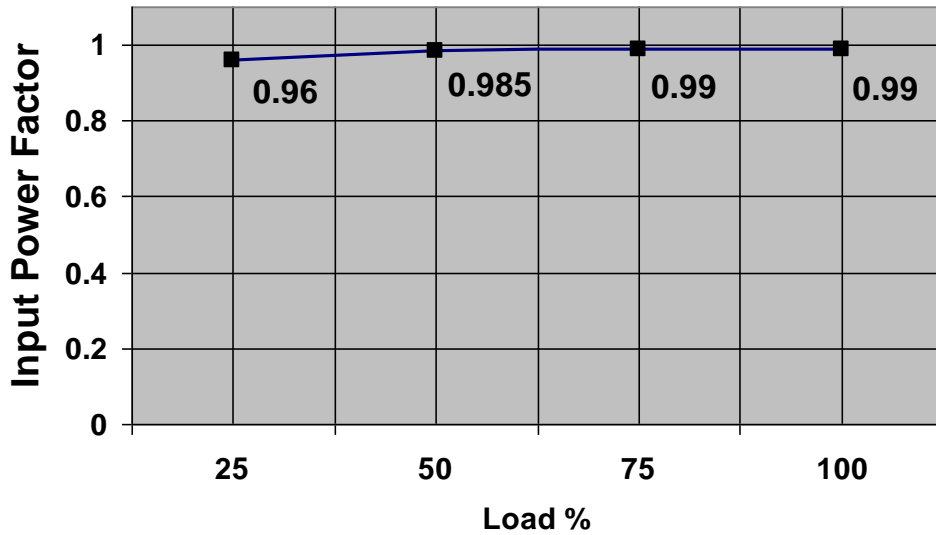
Max. Power connection	kW	400	500
Dimensions (WxHxD)	mm	2150x1994x850	
Dimensions with elevation kit (WxHxD)	mm	2150x2094x850	
Weight with TCE Basic	kg	950+115	1000+115
Weight with TCE single input feed with cables	kg	950+245	1000+245
Weight with TCE dual input feed with cables	kg	950+285	1000+285
Colour		Graphite grey (RAL 7024)	

**10.3 INPUT CHARACTERISTICS**

UPS Model		PW 33 60	PW 33 80	PW 33 100	PW 33 120	PW 33 160	PW 33 200	PW 33 250	PW 33 300	PW 33 400	PW 33 500
Output Rated Power	kW	60	80	100	120	160	200	250	300	400	500
Nominal Input Voltage	V	3x380/220V+N, 3x400V/230V+N, 3x415/240V+N									
Input Voltage Tolerance (ref to 3x400/230V) for Loads in %:	V	(-23%/+15%) 3x308/177 V to 3x460/264 V for <100 % load (-30%/+15%) 3x280/161 V to 3x460/264 V for < 80 % load (-40%/+15%) 3x240/138 V to 3x460/264 V for < 60 % load									
Input Frequency	Hz	35 – 70									
Input Power Factor		PF=0.99 @ 100 % load									
Inrush Current	A	limited by soft start / max. In									
Input Distortion THDi @ 100% load	%	3.5									4.0
Max. Input Power with rated output power and charged battery (output cosφ = 1.0)	kW	64	85	107	128	170	213	266	319	426	532
Max. Input Current with rated output power and charged battery (output cosφ = 1.0)	A	93	123	154	185	247	308	386	463	617	771
Max. Input Power with rated output power and discharged battery (output cosφ = 1.0)	kW	70	94	110	141	187	234	293	351	468	585
Max. Input Current with rated output power and discharged battery (output cosφ = 1.0)	A	102	136	160	204	271	339	424	509	679	848

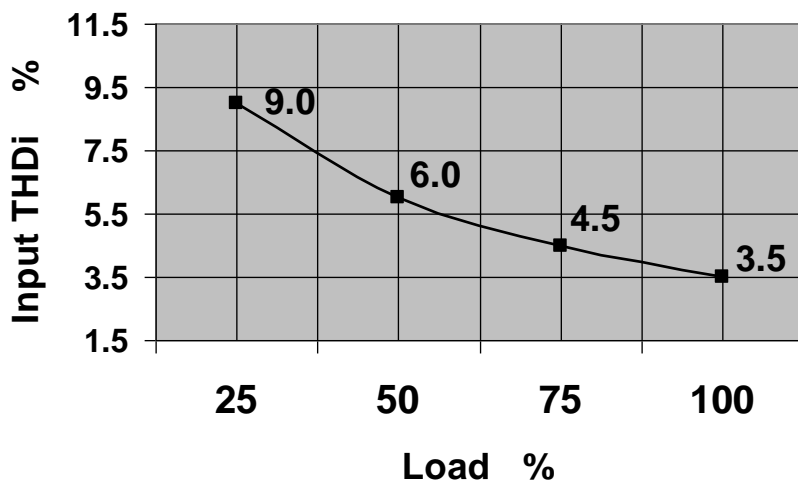
10.3.1 GRAPH: INPUT PF VERSUS % LOAD

Input Power factor (Leading)



10.3.2 GRAPH: INPUT DISTORTION THDi VERSUS % LOAD

Input Current Distortion THDi





**10.4 BATTERY CHARACTERISTICS**

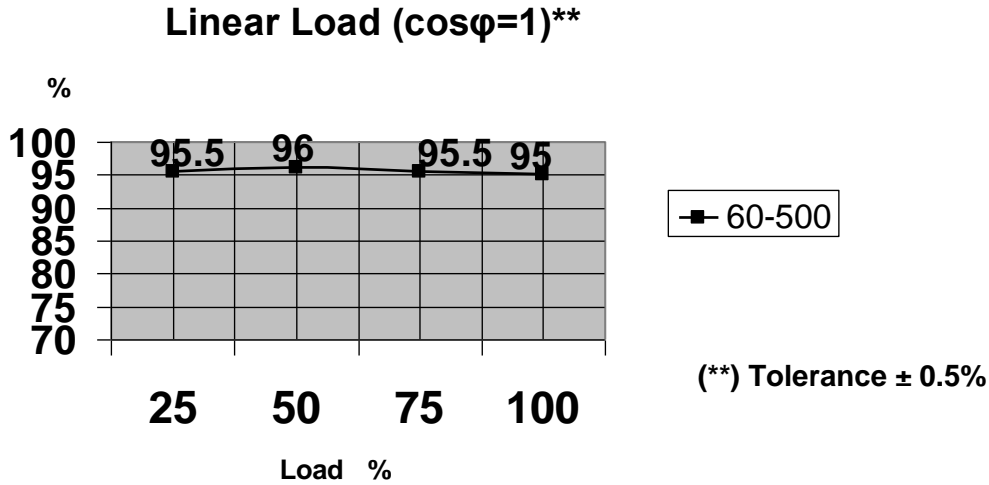
UPS Range		60 kW	80 kW	100 kW	120 kW	160 kW	200 kW	250 kW	300 kW	400 kW	500 kW
Min/Max Number of 12V Battery Blocks @ PF=1.0	No.	44 / 50			44 / 50		50	44 / 50		44 / 50	
Maximum Battery Charger Current	A	25A			50A			60A		100A	
Battery Charging Curve	Ripple free ; IU (DIN 41773)										
Temperature compensation ready	Standard (temp. sensor optional)										
Battery Test	Automatic and periodically (adjustable)										
Battery Type	Maintenance free VRLA or NiCd										

**10.5 OUTPUT CHARACTERISTICS**

UPS Range		60 kW	80 kW	100 kW	120 kW	160 kW	200 kW	250 kW	300 kW	400 kW	500 kW
Output Rated Power (@ min. 44 battery blocks)	kVA	60	80	100	120	160	200 <sup>*1</sup>	250	300	400	500
Output Rated Power (@ min. 44 battery blocks)	KW	60	80	100	120	160	200 <sup>*1</sup>	250	300	400	500
Output Current In PF 1.0 (400 V) (@ min. 44 battery blocks)	A	87	116	145	174	232	290	361	433	577	722
Output Rated Voltage	V	3x380/220V or 3x400/230V or 3x415/240V									
Output Voltage Stability	%	Static: Dynamic (Step load 0%-100% or 100%-0%)									< +/- 1% < +/- 4%
Output Voltage Distortion	%	With Linear Load With Non-linear Load (EN62040-3:2001)									< 2% < 4%
Output Frequency	Hz	50 Hz or 60 Hz									
Output Frequency Tolerance	%	Synchronized with mains (selectable for bypass operation) Free running									< +/- 2% or < +/- 4% +/- 0.1%
Bypass operation		At Nominal Input voltage of 3x400 V or 190 V to 264 V ph-N									+/- 15%
Permissible Unbalanced Load (All 3 phases regulated independently)	%	100%									
Phase Angle Tolerance (With 100 % Unbalanced load)	Deg.	+/- 0 deg.									
Overload Capability on Inverter	%	At PF 1.0 110% load			At PF 1.0 135% load			10 min. 1 min.			
Output short capability (RMS)	A	Inverter: .....x In during 40 ms 2.7   2.0   2.3   1.8   1.9   2.1   2.0   2.0   2.0   2.0 Bypass: 10 x In during 10 ms									
Crest – Factor (Load supported)		3 : 1									

\*1) only with 50 battery blocks

10.5.1 GRAPH: AC – AC EFFICIENCY with Linear load @ cosφ 1



10.5.2 GRAPH: Output Power in KW and KVA VERSUS cosφ  
 Vout=230Vac rms line to neutral, 50Hz, ≥ 44 battery blocks

	PW33	60		80		100	
	PF	kW	kVA	kW	kVA	kW	kVA
CAP	0.80	46	58	61	77	77	97
	0.85	50	59	66	78	83	98
	0.90	54	60	72	80	90	100
	0.95	57	60	76	80	95	100
	1.00	60	60	80	80	100	100
IND	0.95	57	60	76	80	95	100
	0.90	54	60	72	80	90	100
	0.85	51	60	68	80	85	100
	0.80	48	60	64	80	80	100
	0.75	45	60	60	80	75	100
	0.70	42	60	56	80	70	100
	0.65	39	60	52	80	65	100
0.60	36	60	48	80	60	100	

	PW33	120		160		200 (*)	
	PF	kW	kVA	kW	kVA	kW	kVA
CAP	0.80	92	116	122	154	154	194
	0.85	100	117	132	156	166	195
	0.90	108	120	144	160	180	200
	0.95	114	120	152	160	190	200
	1.00	120	120	160	160	200	200
IND	0.95	114	120	152	160	190	200
	0.90	108	120	144	160	180	200
	0.85	102	120	136	160	170	200
	0.80	96	120	128	160	160	200
	0.75	90	120	120	160	150	200
	0.70	84	120	112	160	140	200
	0.65	78	120	104	160	130	200
0.60	72	120	96	160	120	200	

Changes of this tables without notice – modifications reserved

(\*) only using 50 battery blocks

	PW33	250		300		400		500	
	PF	kW	kVA	kW	kVA	kW	kVA	kW	kVA
CAP	0.80	193	241	231	291	310	388	388	485
	0.85	208	245	249	294	333	392	417	490
	0.90	225	250	270	300	360	400	450	500
	0.95	238	250	285	300	380	400	475	500
	1.00	250	250	300	300	400	400	500	500
IND	0.95	238	250	285	300	380	400	475	500
	0.90	225	250	270	300	360	400	450	500
	0.85	213	250	255	300	340	400	425	500
	0.80	200	250	240	300	320	400	400	500
	0.75	188	250	225	300	300	400	375	500
	0.70	175	250	210	300	280	400	350	500
	0.65	163	250	195	300	260	400	325	500
0.60	150	250	180	300	240	400	300	500	

**10.6 ENVIRONMENTAL CHARACTERISTICS**

UPS range		60 kW	80 kW	100 kW	120 kW	160 kW	200 kW	250 kW	300 kW	400 kW	500 kW
Audible Noise at 1m from front 100% / 50% Load	dBA	66 / 56 <sup>1)</sup>			69 / 60 <sup>1)</sup>			71 / 65 <sup>1)</sup>		78.5 / 73.6 <sup>2)</sup>	
Operation temperature	°C	0 – 40									
Ambient Temperature for Batteries (recommended)	°C	20 – 25									
Storage Temperature	°C	-25 - +70									
Battery Storage Time at Ambient Temperature		Max. 6 months									
Max. altitude (above sea level)	m	1000m (3300ft) without de-rating									
De-rating factor for use at altitudes above 1000m sea level according (IEC 62040-3)		Meter above sea level (m / ft)					De-Rating Factor for Power				
		1500 / 4850					0.95				
		2000 / 6600					0.91				
		2500 / 8250					0.86				
3000 / 9900					0.82						
Relative Air-humidity		Max. 95% (non-condensing)									
Accessibility		Totally front accessibility for service and maintenance (no need for side, top or rear access)									
Positioning		Min. 20 cm rear space (required for fan)									
Input and Output Power Cabling		From the bottom on the front									
Efficiency AC-AC up to (at cosφ 1.0) (depending on UPS power)	%	Load : 100 % 75 % 50 % 25 % 95 % 95.5 % 96 % 95.5 %									
Eco-Mode efficiency at 100% load	%	99 %									

<sup>1)</sup>approximate value

<sup>2)</sup>noise reduction kit available on request

**10.7 STANDARDS**

UPS range	60 kW	80 kW	100 kW	120 kW	160 kW	200 kW	250 kW	300 kW	400 kW	500 kW
Safety	IEC/EN 62040-1-1, IEC/EN 60950-1/A11									
Electromagnetic Compatibility	IEC/EN 62040-2, IEC/EN61000-3-2, IEC/EN61000-6-2,									
EMC Classes C2 domestic or industrial In < 16A C3 industrial In >16A	C3									
	C2 optional with filter								not availab.	
Performance	IEC/EN62040-3:2001									
Product certification	CE									
Degree of protection	IP 20									

**10.8 COMMUNICATION**

Power Management Display (PMD)	LCD display (Optional 7" touchscreen display)	
RS232 on Sub-D9 port RS232 on USB port	For monitoring and integration in network management	
Customer Interfaces : Inputs DRY PORT	1 Remote Shut down [EMERGENCY OFF (Normally closed)] 1 GEN-ON (Normally open) 1 Programmable Customer's Inputs (Normally open) 1 Temp. Sensor for Battery Control	
Customer Interfaces : Outputs DRY PORT	6 voltage free contacts For remote signalling and automatic computer shutdown	
RS485 on RJ45 port	Remote monitoring system with graphical display	Option
RS485 on RJ45 port	For multidrop purpose	Option
Slot for SNMP	SNMP card For monitoring and integration in network management	Option

**10.8.1 POWER MANAGEMENT DISPLAY (PMD)**

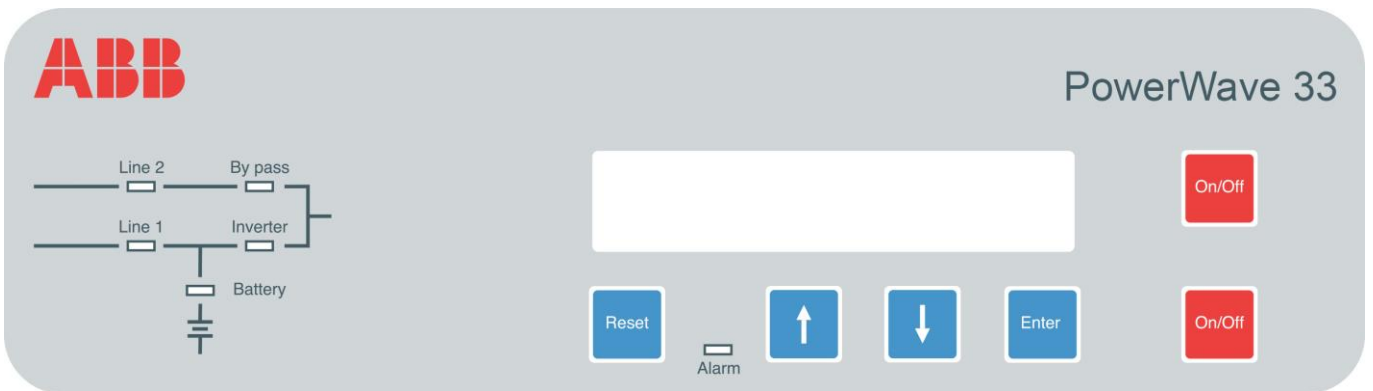
The user-friendly PMD consists of three parts the MIMIC DIAGRAM, CONTROL KEYS and LCD that provides the necessary monitoring information about the UPS.

**10.8.2 MIMIC DIAGRAM**

The mimic diagram serves to give the general status of the UPS. The LED-indicators show the power flow status and in the event of mains failure or load transfer from inverter to bypass and vice-versa the corresponding LED-indicators will change colour from green (normal) to red (warning). The LED's LINE 1 (rectifier) and LINE 2 (bypass) indicate the availability of the mains power supply. The LED's INVERTER and BYPASS if green indicate which of the two are supplying power to the critical load. When the LED-indicator BATTERY is lit it means that the battery due to mains failure is supplying the load. The LED-indicator ALARM is a visual indication of any internal or external alarm condition. At the same time the audible alarm will be activated.

**10.8.3 DISPLAY**

The 2 x 20 character LCD or the optional 7 inches touchscreen display simplify the communication with the UPS. The menu driven display enables the access to the EVENT REGISTER, or to monitor the input and output U, I, f, P, Autonomy Time and other Measurement's, to perform commands like start-up and shut-down of INVERTER or load transfer from INVERTER to BYPASS and vice-versa and finally it serves for the DIAGNOSIS (SERVICE MODE) for adjustments and testing (for more details see the USER MANUAL of PowerWave 33).



Power Management Display (PMD) of PowerWave 33



Optional 7" touchscreen graphical display

**10.8.4 CUSTOMER INTERFACES (PW33 60-300 kW)**

**10.8.5 CUSTOMER INPUTS DRY PORTS: Terminal block X1**
















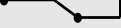


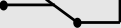






Connection of Remote Shut down facilities, Generator Operation, Customers specials (see UM Section 9 / OPTIONS)

**10.8.6 CUSTOMER OUTPUTS DRY PORTS : Terminal blocks X2**

Provision of signals for the automatic and orderly shutdown of servers, AS400 or Automation building systems

All voltage free contacts are rated 60 VAC max. and 500 mA max.:

All the interfaces are connected to Phoenix Spring terminals with wires : 0.5 mm<sup>2</sup>

Block	Terminal	Contact	Signal	On Display	Function
X1	X1 / 10	GND 	GND		<b>12 Vdc source</b> (Max 200mA load)
	X1 / 9	IN 	+12Vdc		
	X1 / 8	GND 	GND		<b>Remote Shut down</b> (Do not remove the factory mounted bridge until an external remote shut down is connected)
	X1 / 7	IN 	+12Vdc		
	X1 / 6	GND 	GND		<b>Temperature Battery</b> (If connected, the battery charger current is batt. temperature dependent)
	X1 / 5	IN 	+3.3Vdc		
	X1 / 4	GND 	GND		<b>Customer IN 1</b> (Function on request, to be defined)
	X1 / 3	IN 	+12Vdc		
	X1 / 2	GND 	GND		<b>Generator Operation</b>
X1 / 1	IN 	+12Vdc			
X2	X2 / 15	C 	ALARM	COMMON_ALARM	Common
	X2 / 14	NC 		NO Alarm Condition	
	X2 / 13	NO 		<b>Common Alarm (System)</b>	
	X2 / 12	C 	Message	LOAD_ON_MAINS	Common
	X2 / 11	NC 		(Load on Inverter)	
	X2 / 10	NO 		<b>Load on bypass (Mains)</b>	
	X2 / 9	C 	ALARM	BATT_LOW	Common
	X2 / 8	NC 		Battery OK	
	X2 / 7	NO 		<b>Battery Low</b>	
	X2 / 6	C 	Message	LOAD_ON_INV	Common
	X2 / 5	NC 		(Load on Mains bypass)	
	X2 / 4	NO 		<b>Load on Inverter</b>	
	X2 / 3	C 	ALARM	MAINS_OK	Common
	X2 / 2	NC 		<b>Mains Failure</b>	
	X2 / 1	NO 		Mains Present	

Customer Interface PowerWave 33 60-300 kW X1, X2 Phoenix Terminals

**10.8.7 CUSTOMER INTERFACES (PW33 400-500 kW)**

**10.8.8 CUSTOMER INPUTS DRY PORTS: Terminal blocks X3 / 3-14**

Connection of Remote Shut down facilities, Generator Operation, Customers specials (see UM Section 9 / OPTIONS)

**10.8.9 OUTPUTS DRY PORTS: Terminal blocks X2 + X3 / 1-2**

Provision of signals for the automatic and orderly shutdown of servers, AS400 or Automation building systems

**10.8.10 INTERLOCK CASTELL FUNCTION: Terminal block X1**

This function allows a secure transfer from inverter (normal operation) to external maintenance bypass and vice-versa. During normal operation the external bypass is locked in position OFF. Only when the UPS is/are transferred to static bypass mode, the lock on the external bypass is released and it possible to switch to position ON. The transfer from maintenance bypass back to normal operation happens exactly the other way around. The release signal is 230VAC when the maintenance bypass is free and 0V when locked.

All Terminals X1-X3 can hold Cable from 0.2mm2 – 1.5mm2  
 X1 is a 230VAC output which allows to interface with a interlock system.  
 All X2 are potential free contacts and are rated: Max 250Vac/8A; 30Vdc/8A; 220Vdc/0.12A  
 All X3 (except X3 5/6 which is a 12VDC source) are inputs, cable max. R 50Ω at 20mA

Block	Terminal	Contact	Signal	On Display	Function
X3	X3 / 14	GND	GND	-	Battery Temperature (only the optional battery sensor from ABB is compatible)
	X3 / 13	IN	+3.3VDC	-	
	X3 / 12	GND	GND	GENERATOR_ OPER_ON	Generator Operation (N.O.) Min. contact load 12V / 1mA
	X3 / 11	IN	+12Vdc		
	X3 / 10	GND	GND	PARRALEL_SW_OPEN PARRALEL_SW_CLOSE	External Output Breaker (N.O.) Min. contact load 12V / 20mA.
	X3 / 9	IN	+12Vdc		
	X3 / 8	GND	GND	EXT_MAN_BYP	External Manual Bypass (Ext. IA1) (N.O.) Min. contact load 20mA
	X3 / 7	IN	+12Vdc		
	X3 / 6		+12Vdc	-	+ 12 VDC source (UPS protected) (Max. 200mA)
	X3 / 5		GND	-	
	X3 / 4	GND	GND	REMOTE_ SHUTDOWN-	RSD (Remote Shut down) Default setting: disabled. Possibility to enable and set NO or NC via NewSet.
	X3 / 3	IN	+12Vdc		
	X3 / 2		-	REMOTE_ SHUTDOWN-	RSD (Remote Shut down ) for external switch Max. 250Vac/8A ;30Vdc/8A ;110Vdc/0.3A ;220Vdc/0.12A
	X3 / 1		-		
X2	X2 / 18		-	-	Common
	X2 / 17		-	-	Relais AUX
	X2 / 16		-	-	(function on request, to be defined)
	X2 / 15		-	COMMON_ALARM	Common
	X2 / 14		ALARM	No Alarm Condition	
	X2 / 13		-	Common Alarm (System)	
	X2 / 12		-	LOAD_ON_MAINS	Common
	X2 / 11		Message	No Load on Bypass	
	X2 / 10		-	Load On Bypass (Mains)	
	X2 / 9		-	BATT_LOW	Common
	X2 / 8		ALARM	Battery Ok	
	X2 / 7		-	Battery Low	
	X2 / 6		-	LOAD_ON_INV	Common
	X2 / 5		Message	No Load on Inverter	
	X2 / 4		-	Load on Inverter	
	X2 / 3		-	MAINS_OK	Common
	X2 / 2		ALARM	Mains Failure	
	X2 / 1		-	Mains Present	
X1	X1 / 2		-	EXT_MAN_BYP	Interlock Function (Ext Manual Bypass) 230Vac / 2AT

Customer Interface Conceptpowe PW33 400-500KW

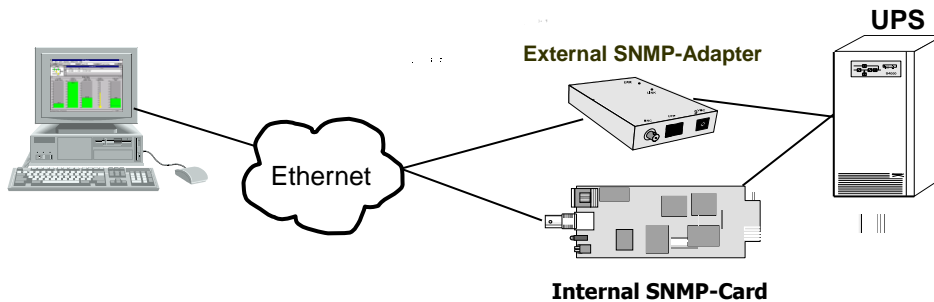
## 10.9 OPTIONS

- SNMP card and WaveMon Management Software , Modbus Protocol, USB
- External Battery Cabinets
- Parallel kit, Synchron kit
- In/output Transformer for special voltages
- Back-feed protection
- Temp. sensor for battery temp. control
- Top Cable Entry Enclosure (TCE)

### 10.9.1 SNMP card / WaveMon Management Software



The Simple Network Management Protocol (SNMP) is a worldwide-standardized communication-protocol. It is used to monitor any device in the network via simple control language. The UPS-Management Software WaveMon also provides its data in this SNMP format with its internal software agent. The operating system you are using must support the SNMP protocol. We offer our WaveMon software with SNMP functionality for Novell, OS/2, all Windows running on INTEL and ALPHA, DEC VMS, Apple.

Two types of SNMP interfaces with identical functionality are available: an external SNMP-Adapter (Box) and an internal SNMP-Card. Both can manage a parallel system (N modules) and return either global values - which are consistent for the whole parallel system - or specific values from the single modules.





**10.9.2 Battery Enclosures**

<p>The integrated battery enclosures are part of the UPS, therefore cannot be defined as a separate battery cabinet</p>		<p align="center"><b>UPS &amp; BAT- ENC A</b> Only for 60, 80 and 100kW</p>	<p align="center"><b>UPS &amp; BAT- ENC B</b> Only for 60, 80 and 100kW</p>
<p><b>BAT- ENC A &amp; B</b></p>			
<p>Configuration accommodates:</p>	<p>Max.</p>	<p>80 Batt. Blocks for 28Ah mounted on 16 shelves (5 blocks/shelf)</p>	<p>120 Batt. Blocks for 28Ah mounted on 24 shelves (5 blocks/shelf)</p>
<p>Strings : Terminals :</p>		<p align="center">2 3 x M8</p>	<p align="center">3 3 x M8</p>
<p>Fuse Type (Very Fast acting)</p>	<p>A</p>	<p align="center">2 x 3 x 100A</p>	<p align="center">3 x 3 x 100A</p>
<p>Dimensions of UPS and battery Side (WxHxD)</p>	<p>mm</p>	<p align="center">970x1820x750</p>	<p align="center">1180x1820x750</p>
<p>Weight w/o trays and w/o batteries</p>	<p>kg</p>	<p align="center">20</p>	<p align="center">30</p>
<p>Battery configuration with BAT-ENC A &amp; B</p>		<p align="center">Batt. Config. (2x40)x28Ah</p>	<p align="center">Batt. Config. (3x40)x28Ah</p>

**10.9.3 Top Cable Entry Enclosure (TCE)**



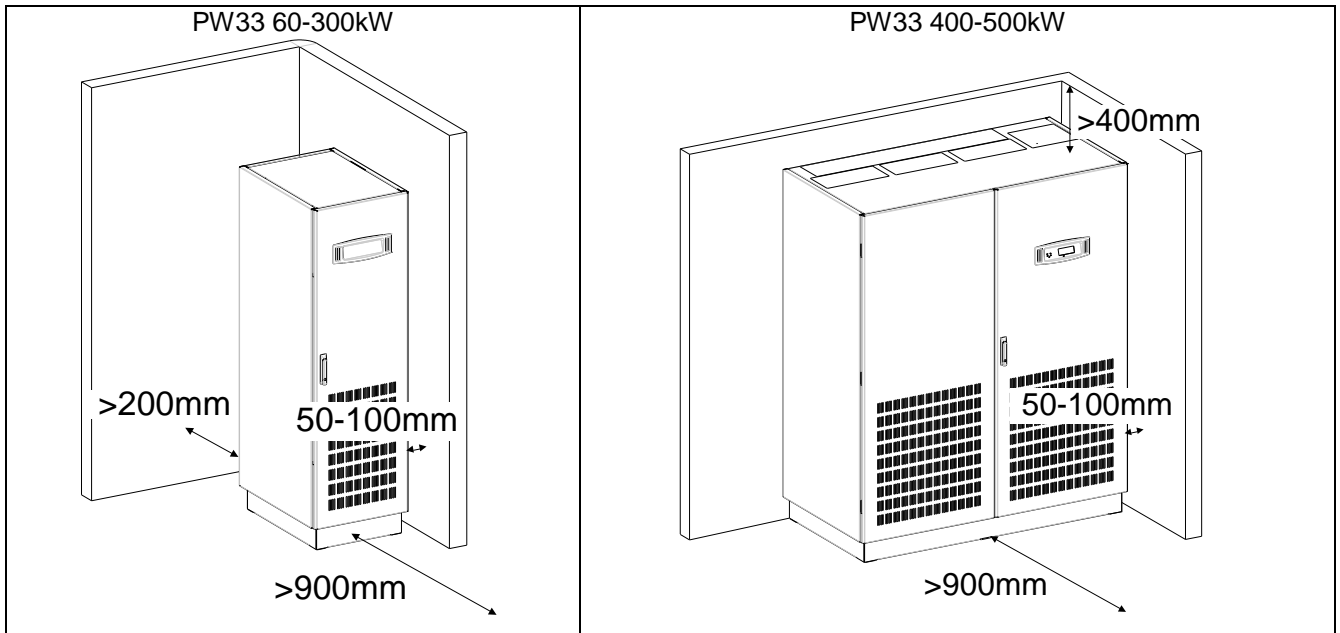
Max. Power connection	kW	400	500
Dimensions (WxHxD)	mm	2150x1994x850	
Dimensions with elevation kit (WxHxD)	mm	2150x2094x850	
Weight with TCE Basic	kg	950+115	1000+115
Weight with TCE single input feed with cables	kg	950+245	1000+245
Weight with TCE dual input feed with cables	kg	950+285	1000+285
Colour		Graphite grey (RAL 7024)	

**10.10 BATTERY AUTONOMIES**

**10.10.1 EXAMPLES OF BATTERY AUTONOMY AT FULL LOAD WITH STANDARD BATTERY CABINETS AND STANDARD BATTERY CONFIGURATION**

<b>28Ah battery</b>											
<b>UPS Range</b>		<b>60kW</b>	<b>80kW</b>	<b>100kW</b>	<b>120kW</b>	<b>160kW</b>	<b>200kW</b>	<b>250kW</b>	<b>300kW</b>	<b>400kW</b>	<b>500kW</b>
<b>BAT-ENC</b>	<b>Battery configuration</b>	<b>Autonomy time in minutes @ 80% Load (kW)</b>									
	Batt. Enclosure A (2x40)x28Ah	13	9	7	<b>not available</b>						
	Batt. Enclosure B (3x40)x28Ah	22	15	12							

**10.11 INSTALLATION PLANNING**



**Figure 1-2 : UPS Positioning and space recommendation**

UPS Frame type	60-100 kW	60-80-100 kW (with battery enclosure A&B)	120-200 kW	250-300 kW	400-500 kW
Dimensions (WxHxD) mm	550x1820x750	A: 970x1820x750 B: 1180x1820x750	850x1820x750	1100x1920x750	1650x1994x850
Fan position	back				on top
Accessibility	Totally front accessibility for service and maintenance (no need for side, top or rear access)				
Positioning	Min. 200 mm rear space (required for fan)				Rear side directly at the wall
Input and Output Power Cabling	From the bottom on the front				

**10.11.1 MAXIMUM HEAT DISSIPATION PER UPS RANGE WITH NON-LINEAR LOAD**

UPS Range		60 kW	80 kW	100 kW	120 kW	160 kW	200 kW	250 kW	300 kW	400 kW	500 kW
Air-flow		from front to back								from front to top	
Heat Dissipation with 100% Non-linear Load per range (EN 62040-1-1)	W	3830	5106	6383	7660	10213	12766	15957	19149	24000	30000
Heat Dissipation with 100% Non-linear Load per range (EN 62040-1-1)	BTU /h	13071	17428	21785	26142	34856	43570	54462	65355	81913	102389
Airflow (25° - 30°C) with 100% Non-linear Load per range (EN 62040-1-1)	m <sup>3</sup> /h	1300	1500	1700	2500	2500	2500	3350	3350	6550	6550
Heat Dissipation without load	W	850	850	850	1500	1500	1500	2300	2300	4000	4000

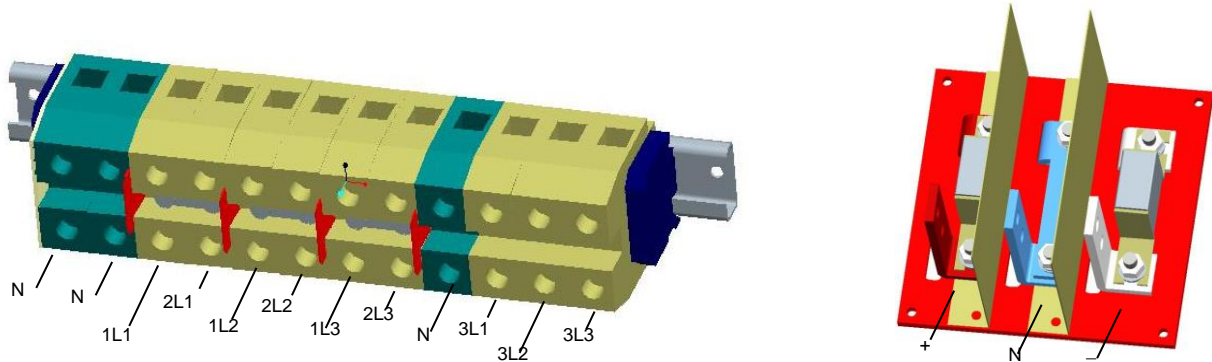
**10.12 WIRING AND BLOCK DIAGRAMS FOR ALL UPS FRAMES**

The customer has to supply the wiring to connect the UPS to the local power source. The installation inspection and initial start up of the UPS and extra battery cabinet must be carried out by a qualified service personnel such as a licensed service engineer from the manufacturer or from an agent certified by the manufacturer. More details and procedure are mentioned in the user manual.

**10.12.1 TERMINAL CONNECTIONS OVERVIEW**

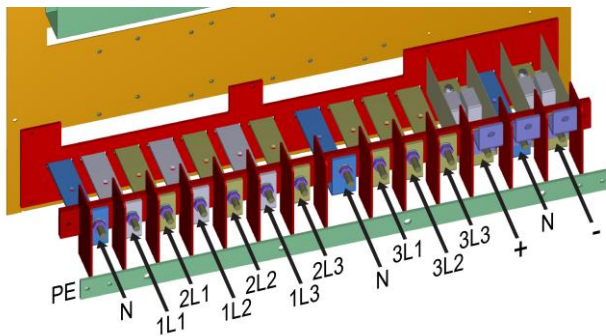
UPS Range Terminals (T) Connection Bar (B)	Battery (+ / N / -) +PE	Input Bypass 3+N (N,2L1,2L2,2L3)	Input Rectifier 3+N+PE (N,1L1,1L2,1L3)	Output load 3+N+PE (N,3L1,3L2,3L3)	Max. cable section admissible (mm <sup>2</sup> )	Toghtening Torque (Nm)
<b>60kW (Fig.1)</b>	4 x M8	4 x 35 mm <sup>2</sup>	4 x 35 mm <sup>2</sup> + PE M8	4 x 35 mm <sup>2</sup> + PE M8	35	3.5
<b>80kW (Fig.1)</b>	4 x M8	4 x 50 mm <sup>2</sup>	4 x 50 mm <sup>2</sup> + PE M8	4 x 50 mm <sup>2</sup> + PE M8	50	5
<b>100kW (Fig.1)</b>	4 x M8	4 x 70 mm <sup>2</sup>	4 x 70 mm <sup>2</sup> + PE M8	4 x 70 mm <sup>2</sup> + PE M8	95	8
<b>120kW (Fig.2)</b>	4 x M10	4 x M10	5 x M10	5 x M10	185	Max. 50
<b>160kW (Fig.2)</b>	4 x M10	4 x M10	5 x M10	5 x M10	185	Max. 50
<b>200kW (Fig.2)</b>	4 x M10	4 x M10	5 x M10	5 x M10	240	Max. 50
<b>250kW (Fig.3)</b>	4 x M10	4 x M10	5 x M10	5 x M10	240	Max. 50
<b>300kW (Fig.3)</b>	4 x M10	4 x M10	5 x M10	5 x M10	240	Max. 50
<b>400kW (Fig.4)</b>	3 x 4xM12	3 x 4 x M12	3 x 5 x M12	3 x 5 x M12	240	Max. 84
<b>500kW (Fig.4)</b>	3 x 4xM12	3 x 4 x M12	3 x 5 x M12	3 x 5 x M12	240	Max. 84

**Fig. 1: 60-80-100 kW**

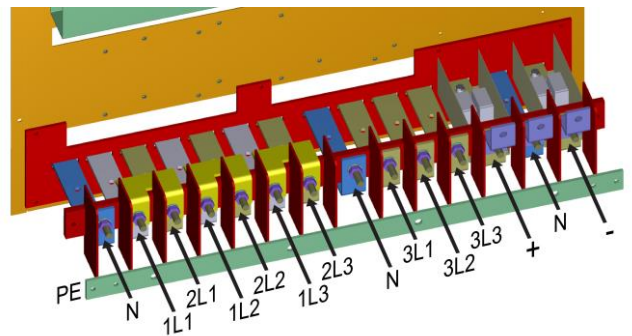


**Fig. 2: 120-160-200 kW**

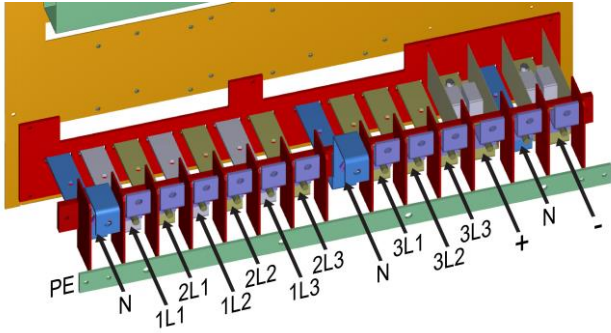
Standard dual input feed connections



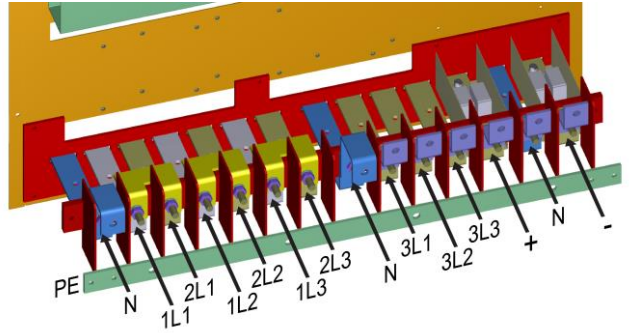
Standard single input feed connections



With option 04-1530 double-cable connection dual input feed

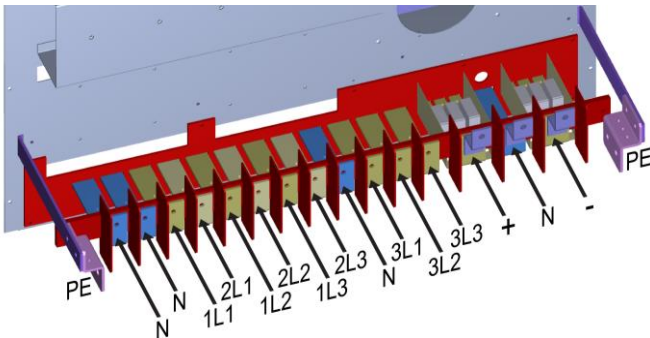


With option 04-1529 double-cable connection single input feed

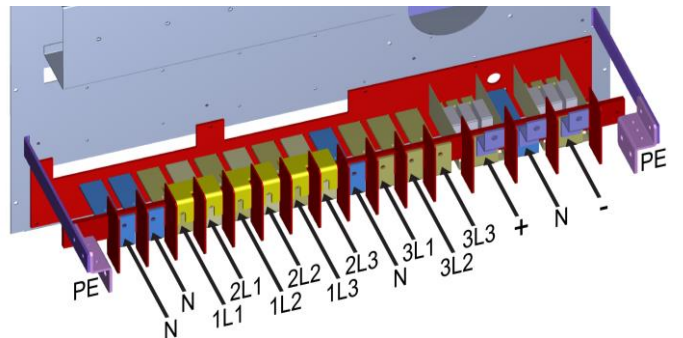


**Fig. 3: 250-300 kW**

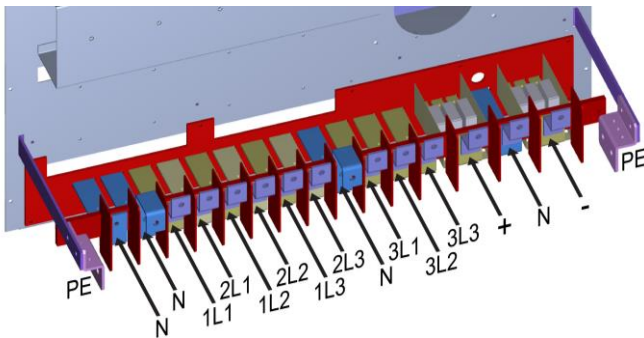
Standard dual input feed connections



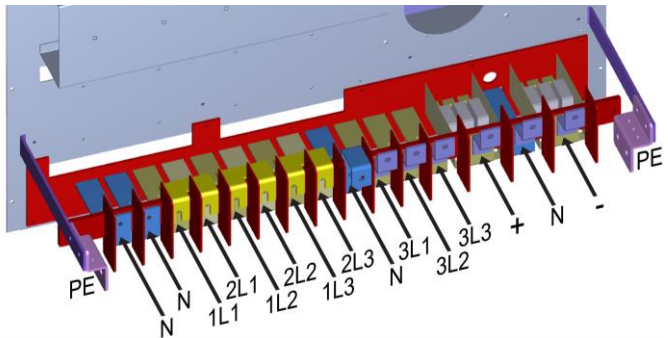
Standard single input feed connections



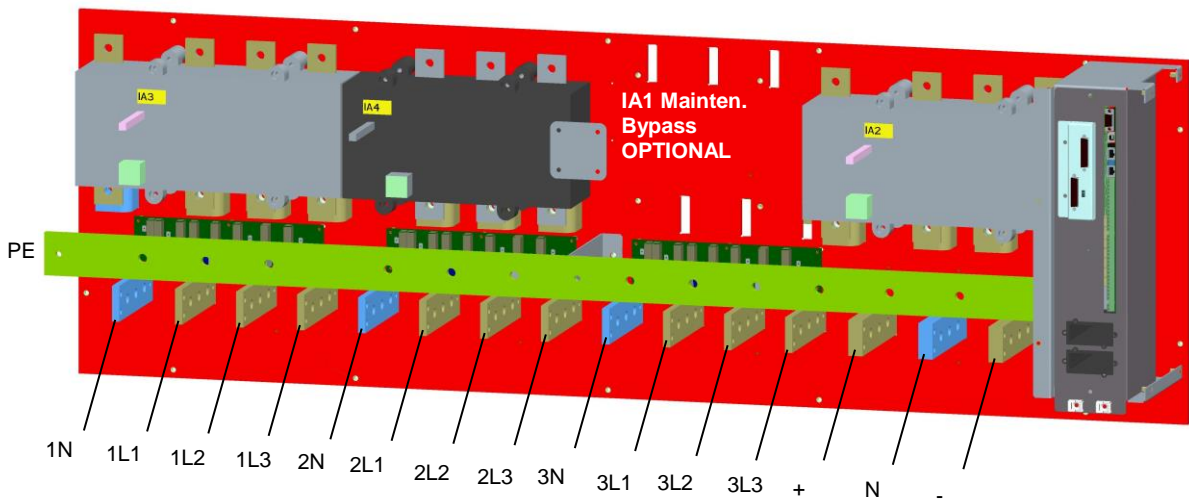
With option 04-1530 double-cable connection dual input feed



With option 04-1529 double-cable connection single input feed



**Fig. 4: 400-500 kW**



10.12.2 INPUT FEED RATINGS POWERWAVE 33 60-300kW

Cable Sections and Fuse Ratings recommended. Alternatively, local standards to be respected

Block Diagram

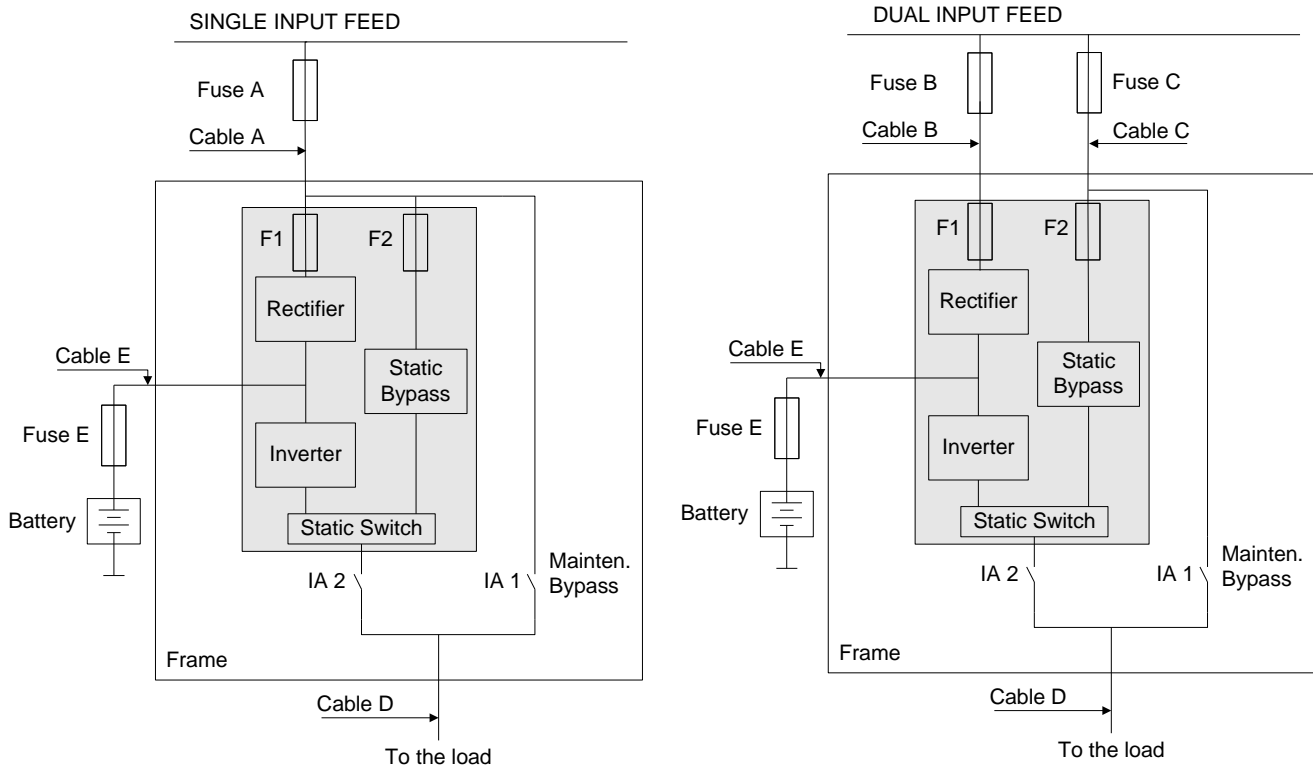


Figure 5: Block Diagram PowerWave 33 from 60-300kW

SINGLE INPUT FEED

Power (kW)	Fuse A (Agl/CB)	Cable A (IEC 60950-1)	Cable D (IEC 60950-1)	Fuse E +/N/-	Cable E +/N/-
60	3x100	5x35	5x35	3x125A	3x35+ PE
80	3x125	5x50	5x50	3x160A	3x50 + PE
100	3x160	5x50	5x50	3x250A	3x95 + PE
120	3x200	5x70	5x70	3x250A	3x120 + PE
160	3x250	5x120 or 5x(2x50) <sup>1</sup>	5x120 or 5x(2x50) <sup>1</sup>	3x350A	3x(2x70) + PE
200	3x350	5x185 or 5x(2x70) <sup>1</sup>	5x185 or 5x(2x70) <sup>1</sup>	3x450A	3x(2x95) + PE
250	3x400	5x240 or 5x(2x95) <sup>1</sup>	5x240 or 5x(2x95) <sup>1</sup>	3x630A	3x(2x150) + PE
300	3x500	5x(2x120) <sup>1</sup>	5x(2x120) <sup>1</sup>	3x630A	3x(2x150) + PE

DUAL INPUT FEED

Power (kW)	Fuse B (Agl/CB)	Cable B (IEC 60950-1)	Fuse C (Agl/CB)	Cable C (IEC 60950-1)	Cable D (IEC 60950-1)	Fuse E +/N/-	Cable E +/N/-
60	3x100	5x35	3x100	5x35	5x35	3x125A	3x35+ PE
80	3x125	5x50	3x125	5x50	5x50	3x160A	3x50+ PE
100	3x160	5x50	3x160	5x50	5x50	3x250A	3x95+ PE
120	3x200	5x70	3x200	5x70	5x70	3x250A	3x120+ PE
160	3x250	5x120 or 5x(2x50) <sup>2</sup>	3x250	5x120 or 5x(2x50) <sup>2</sup>	5x120	3x350A	3x(2x70) + PE
200	3x350	5x185 or 5x(2x70) <sup>2</sup>	3x315	5x185 or 5x(2x70) <sup>2</sup>	5x185	3x450A	3x(2x95) + PE
250	3x400	5x240 or 5x(2x95) <sup>2</sup>	3x400	5x240 or 5x(2x95) <sup>2</sup>	5x240 or 5x(2x95)	3x630A	3x(2x150) + PE
300	3x500	5x(2x120) <sup>2</sup>	3x500	5x(2x120) <sup>2</sup>	5x(2x120)	3x630A	3x(2x150) + PE

<sup>1</sup>) only possible with the option "04-1529 double-cable connection single input" feed

<sup>2</sup>) only possible with the option "04-1530 double-cable connection dual input" feed

**10.12.3 INPUT FEED RATINGS POWERWAVE 33 400-500kW**

**Cable Sections and Fuse Ratings recommended. Alternatively, local standards to be respected**

Block Diagram

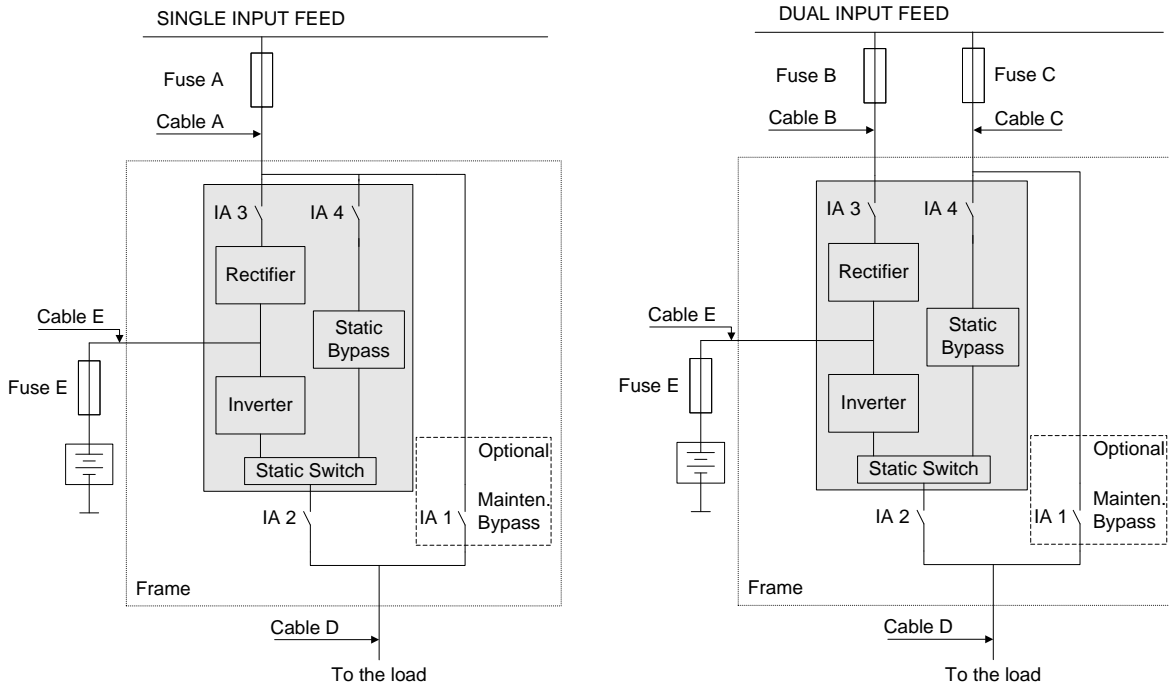


Figure 6: Block Diagram PowerWave 33 from 400-500kW

STANDARD VERSION (SINGLE INPUT FEED)

Power (kW)	Fuse A (Agl/CB)	Cable A (IEC 60950-1)	Cable D (IEC 60950-1)	Fuse E +/N/-	Cable E +/N/-
400	3x630	5x(3x95) or 5x(2x185)	5x(3x95) or 5x(2x185)	3x1000A	3x(3x185) + PE
500	3x800	5x(3x150)	5x(3x150)	3x1250A	3x(3x240) + PE

VERSION ON REQUEST (DUAL INPUT FEED)

Power (kW)	Fuse B (Agl/CB)	Cable B (IEC 60950-1)	Fuse C (Agl/CB)	Cable C (IEC 60950-1)	Cable D (IEC 60950-1)	Fuse E +/N/-	Cable E +/N/-
400	3x630	5x(3x95) or 5x(2x185)	3x630	5x(3x95) or 5x(2x185)	5x(3x95) or 5x(2x185)	3x1000A	3x(3x185) + PE
500	3x800	5x(3x150)	3x800	5x(3x150)	5x(3x150)	3x1250A	3x(3x240) + PE